



spielwarenmesse

Nürnberg 28 Jan – 1 Feb 2025

Stand construction at Spielwarenmesse 2025

1. Important information stand construction
2. Guidelines open stand design
3. Technical regulations
4. Instruction sheet: Suspension points, trusses and lifting equipment
5. Instruction sheet: Enclosed rooms
6. Instruction sheet: Visual contact
7. Instruction sheet: Fire prevention
8. Instruction sheet: Door positioning
9. Instruction sheet: Fire extinguishers
10. Instruction sheet: Explosive Mixtures
11. Instruction sheet: Security Stand Construction Work
12. Instruction sheet: Glass in stand construction inside trade fair halls



1. Important Information stand construction

Please note the following important information regarding stand construction:

▪ **Use of secondary safety components**

In actual use, for luminaires, loudspeakers, monitors, decorations and other items in production and event operations, which are mounted with fixing devices for mobile use (e.g. plug bolts and sleeve, C-hooks), the safety of the suspension is influenced by the quality of the mounting at the place of use.

Therefore, a secondary safety device is required for these applications.

A securing element (safety) must be mounted in such a way that it does not allow any fall path. If a fall path is unavoidable, it must be kept as small as possible.

When securing equipment that must only be aligned after installation, such as spotlights, the maximum fall path of 20cm must not be exceeded.

Additional securing (secondary securing) can only be dispensed with if the fastening device is designed to be "intrinsically safe" and can only be loosened with tools and is secured against self-release.

Intrinsically safe means that the load to be secured is halved according to industrial standards, i.e. the safety factor is doubled. If the securing element (safety rope) allows a fall path, the force generated when the load falls into the securing element must be taken into account. The height of the fall path is decisive here. Under test conditions, forces of up to 50 times the falling load have been demonstrated for a fall distance of 20 cm.

A secondary safety component according to DIN 56927 usually consists of a wire rope, rope termination and fastener. The drop distance should be practically zero. **The use of zip ties is not permitted.** All materials used for suspending loads require precise information on load capacity. Materials without this information must not be used.

▪ **Stand construction and decoration materials**

In general, no materials that are readily flammable, drip on burning or produce toxic gases, or other smoke-forming materials may be installed. This prohibition also includes thermoplastics e. g. rigid polystyrene foam (PU foams, Styropor, Styrodur, EPS, XPS etc.) and PVC.

The materials listed here may also not be used in substructures, insulations or as fillers.

Decoration materials, embellishments, furnishings and also floor covering, banners and curtains must as a minimum meet the categories flame retardant (B1) and must not drip on burning, as per DIN 4102-1 with limited smoke development and/or as per EN 13501-1 as minimum Class B/C – s2, d0.

Not permitted for decorative materials are natural materials with fibrous, resinous or oily surfaces, such as palm, birch, bamboo, thatch, hay, straw, bark mulch, wood chips, peat or similar materials.

Cardboard boxes, wooden pallets, wooden crates or baskets, which by their construction and surface design create a high fire load, are generally not permitted.

The following materials may only be used with suitable fire protection impregnation: Absorbent natural fiber materials, such as jute sacks, woven and knitted fabrics, or similar fabrics. They generally do not meet the "flame retardant" property and may only be used with the specification of suitable fire protection impregnation.



spielwarenmesse

Nürnberg 28 Jan – 1 Feb 2025

- **Meeting rooms and escape routes**

All accessible rooms enclosed on all sides (e.g.: cubicles, meeting rooms, offices) require a visual and acoustic connection to the hall in order to ensure that alarms can be raised in these rooms at all times. The line of sight must be designed in such a way that a clear view is ensured while in the enclosed space, both while sitting and standing.

A window with dimensions of 0.20 m x 0.80 m (width x height) is recommended as the field of vision size. The use of small window cut-outs at head height (e.g. so-called portholes) is not permitted.

If the view over the stand into the hall is not possible (obstruction of view by fixtures, walls, exhibits, etc.), a technical compensation measure (acoustic or optical) must be provided.

- **Exits and emergency routes**

The distance from any point on a stand space to a necessary hall gangway must not exceed 20 m walking distance (§7 VStättV). This also applies to a multi-storey stand.



2. Guidelines open stand design

A visit to the Spielwarenmesse® should be a positive and inspiring experience for all trade visitors. So that this can be achieved, it is vital that the way the stand is designed conveys the idea of transparency to visitors and the ability to communicate with the people at the stand.

The official regulations can be found in the following documents:

Rules for Exhibitors: 15. Stand design and access

Important Information: 7. Stand layout

Exhibitors are responsible for the design and equipment of stands and the necessary assembly. The exhibitor must ensure that the stand design matches the character and image of the fair Spielwarenmesse. The fair organizer is entitled to specify changes in stand design in this connection.

The stand design and product presentation must be conducive to engaging with customers and ensure appropriate access for visitors. As a minimum, please observe the following requirements for the proportion of the total length of the stand sides facing the aisles that must be designed to be open:

- for row stands: 70%
- for corner stands: 50%
- for head / block stands: 25%

Additional
information

What does the term „open design“ mean?

We recommend the following open design options:

- A completely open design that allows visitors to enter the stand area
- Half-height walls/partitioning of the area to the hall aisle, so that a view into the stand area is possible (maximum height 1,20 m)
- The use of transparent materials that allow the stand area to be viewed (e.g. glass or glass-like materials, transparent materials)

Each stand must have a suitably large area that serves as a showcase for the highlights of the product range and is fully accessible to all fair visitors.

Additional
information

Requirements for the „showcase area“

- 25% of the total stand space or at least 30 sqm
- Free accessible for all visitors
- Good visibility
- Presentation of products (not only decoration or other exhibits, not exclusively reception area)
- Contact person of the exhibitor on site



Closed stand walls

Irrespective of the proportion of stand sides that have to be designed openly, stand walls facing the gangways must not be totally closed for a length of more than 6 metres. In case this length is reached, there must then be an opening of at least 2 metres that provides access to or a view into the stand area.

Standwand Frontansicht / stand wall front view

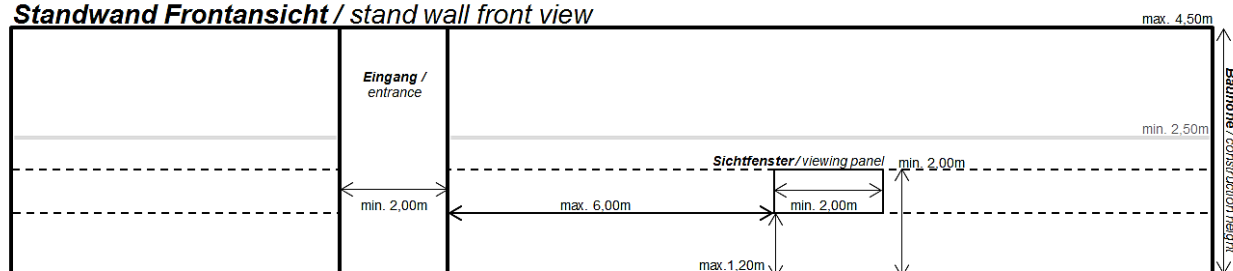

Standwand Frontansicht / stand wall front view

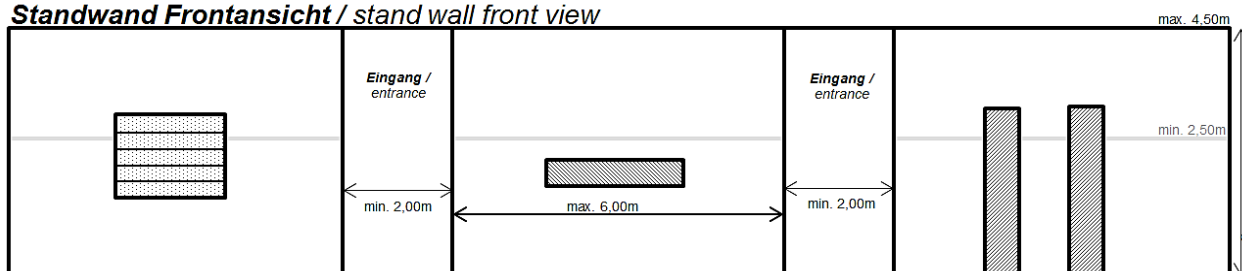

Recommen-
dation

Breaking up of closed walls with:

- Showcases
- Niches
- Displays
- Transparent design elements

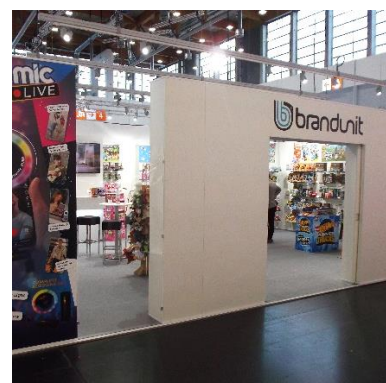

1. Introduction	2	4.9.2 Regulations on building over stand areas, safety clearances, height of rooms in stands	12
1.1 Site regulations, extract from site regulations	2	4.9.3 Permissible loads/load assumptions	12
1.2 Opening times	2	4.9.4 Escape routes, stairs	12
1.2.1 Start of assembly	2	4.9.5 Building materials	12
1.2.2 Duration of event	2	4.9.6 Upper floor	12
1.2.3 Dismantling times	2	4.10 Contraventions/violations and liability	13
1.3 Responsible use of energy	2	5. Industrial safety, technical safety regulations, technical rules, technical supplies	13
2. Traffic in the exhibition grounds, escape routes, safety equipment	3	5.1 General regulations	13
2.1 Traffic regulations	3	5.1.1 Damage	13
2.2 Escape routes	3	5.1.2 Coordination of work at the exhibition stand or event grounds	13
2.2.1 Fire brigade zones, hydrants	3	5.2 Use of tools and equipment	13
2.2.2 Emergency exits, escape hatches, hall gangways	3	5.2.1 Explosive mixtures	13
2.3 Safety equipment	3	5.2.2 Devices for catching wood dust and shavings	13
2.4 Stand numbering	3	5.3 Electrical installation	13
2.5 Security	3	5.3.1 Connections	13
2.6 Emergency evacuation	4	5.3.2 Stand installation	14
3. Technical details and equipment of halls and outdoor area	4	5.3.3 Installation and operating regulations	14
3.1 Hall details	4	5.3.4 Safety measures	14
3.1.1 General lighting, power supply, voltage	4	5.3.5 Emergency lighting	14
3.1.2 Compressed air, electricity and water supply	4	5.4 Water and waste water installation	14
3.1.3 Communication facilities	4	5.4.1 Connections	14
3.1.4 Sprinklers	4	5.4.2 Use of water-bearing systems and equipment	14
3.1.5 Heating, ventilation	4	5.5 Compressed air/gas installation	14
3.1.6 Failures	4	5.5.1 Compressed air	14
3.2 Outdoor area	4	5.5.1.1 Connections	15
4. Stand construction regulations	4	5.5.1.2 Stand installations	15
4.1 Stand safety	4	5.5.1.3 Installation and operating regulations	15
4.2 Approval of stand construction	5	5.5.1.4 Compressed air cylinders	15
4.2.1 Inspection and acceptance of structures requiring approval	5	5.5.1.5 Compressors	15
4.2.2 Vehicles and containers	5	5.5.2 Gas	15
4.3 Construction heights	5	5.6 Machines, pressure vessels, exhaust gas systems	15
4.4 Fire prevention and safety regulations	5	5.6.1 Noise emission	15
4.4.1 Fire protection	5	5.6.2 Product safety	15
4.4.1.1 Stand construction and decoration materials	6	5.6.2.1 Safety devices	15
4.4.1.2 Exhibition and presentation of motor vehicles	6	5.6.2.2 Inspection procedures	15
4.4.1.3 Explosive substances, munitions	6	5.6.2.3 Requirements for start of operation	15
4.4.1.4 Pyrotechnics	6	5.6.2.4 Supplemental protective measures	15
4.4.1.5 Balloons	6	5.6.3 Pressure vessels	16
4.4.1.6 Flying objects	6	5.6.3.1 Acceptance certificate	16
4.4.1.7 Fog machines	7	5.6.3.2 Testing	16
4.4.1.8 Ash container, ashtray, smoking ban	7	5.6.3.3 Rented equipment	16
4.4.1.9 Waste and recycling material containers	7	5.6.3.4 Supervision	16
4.4.1.10 Spray guns, solvents	7	5.6.4 Exhaust gases and vapors	16
4.4.1.11 Abrasive cutting and all other work using naked flame	7	5.6.5 Exhaust gas systems	16
4.4.1.12 Empty packaging/storage of materials	7	5.7 Use of compressed gases, liquid gases and combustible liquids, fuel paste and other fuels	16
4.4.1.13 Fire extinguishers	7	5.7.1 Compressed and liquid gas systems	16
4.4.2 Stand roofing	7	5.7.1.1 Approval of compressed gas cylinders	16
4.4.3 Glass and acrylic glass	8	5.7.1.2 Use of liquid gas	16
4.4.4 Reception rooms/inner rooms	8	5.7.1.3 Installation and maintenance	16
4.5 Exits, escape routes, doors	8	5.7.2 Combustible liquids	16
4.5.1 Exits and escape routes	8	5.7.3 Open flame, fuel paste and other fuels	17
4.5.2 Doors	8	5.8 Hazardous substances	17
4.6 Platforms, ladders, stairs, catwalks	8	5.9 Performance areas	17
4.7 Stand design	9	5.10 Radiation protection	17
4.7.1 Appearance	9	5.10.1 Radioactive substances	17
4.7.2 Verification of rented area	9	5.10.2 X-ray systems and stray radiation sources	17
4.7.3 Interference with building fabric	9	5.10.3 Laser systems	17
4.7.4 Hall floors	9	5.10.4 LEDs	18
4.7.5 Suspending objects from hall ceilings	9	5.11 High-frequency equipment, radio installations, electromagnetic compatibility and harmonics	18
4.7.5.1 Provision of suspension points	10	5.12 Cranes, forklift trucks, empty containers	18
4.7.5.2 Attaching objects to suspension points	10	5.12.1 Displaying heavy and bulky exhibits and machines	18
4.7.5.3 Use of truss systems	10	5.13 Musical reproduction	18
4.7.5.4 Use of lifting equipment	10	5.14 Beverage dispensing systems	18
4.7.5.5 Electric chain hoists	10	5.15 Handling foods	18
4.7.5.6 Manual chain hoists	10	5.15.1 Requirements for stand/kitchen facilities	18
4.7.6 Stand partition walls	11	5.15.2 Cooking appliances and food preparation processes	19
4.7.7 Advertising materials, presentations	11	5.15.3 Grilling/Barbecuing	19
4.7.8 Accessibility	11	6. Environmental protection	19
4.8 Outdoor area	11	6.1 Waste management	19
4.8.1 Stand approval/stand structures requiring permission	11	6.1.1 Waste disposal	19
4.8.2 Excavations and floor anchors	11	6.1.2 Hazardous waste	19
4.8.3 Weather-related loads	11	6.1.3 External waste	19
4.8.3.1 Wind loads	11	6.2 Water, waste water, soil protection	19
4.8.3.2 Wind loads for temporary structures	11	6.2.1 Oil and grease separators	19
4.8.3.3 Snow loads	11	6.2.2 Cleaning, cleaning agents	19
4.8.4 Weather alerts	11	6.3 Environmental damage	20
4.8.5 Exits/escape routes	12		
4.8.6 Glass	12		
4.9 Multi-storey stands	12		
4.9.1 Application	12		

■ 1. Introduction

Spielwarenmesse eG has drawn up regulations for its events with the aim of providing all exhibitors/organizers with optimum facilities for presenting their exhibits and approaching their visitors and potential customers. These regulations are mandatory for all exhibitors, engaged subcontractors and organizers. In the interest of our exhibitors and visitors, these regulations also include safety regulations, which are intended to ensure the highest degree of safety for the technical and design aspects of events. The building regulations, fire prevention regulations and other safety regulations have been agreed with the responsible departments of the Nuremberg authorities. Spielwarenmesse eG reserves the right to check for compliance with these regulations.

Compliance with the applicable statutory regulations is also compulsory. Wherever the term “**Stand Construction**” or “**Stand**” is used in the Technical Regulations in line with accepted linguistic usage, it does not refer to a structure as defined by the German Building Code. In legal terms, an exhibition stand/stand construction in the exhibition halls is an “installation” in a place of assembly.

The organization of an event/operation of an exhibition stand may be prohibited in the interest of all participants if any defects found have not been cleared by the start of the event. The right is reserved to impose further requirements regarding safety and stand construction if necessary. In the remainder of the Technical Regulations, the term “hall” may be used for comparable buildings such as Congress Centres (NCC Mitte, NCC West, NCC Ost), entrance areas, and also corridors between halls.

An **exhibit** as the term is used in this text is a product from the portfolio of goods or products of the exhibitor or organizer, which is exhibited for use appropriate presentation and may also be demonstrated.

The order forms for services are usually sent with the confirmation of admission and must be completed and returned by the specified deadline, as Spielwarenmesse eG cannot accept responsibility for correct and timely execution of orders that are sent late.

Spielwarenmesse eG also reserves the right to impose a surcharge on the price of orders received late, in accordance with details given in the On-line Service Center. If applicable, exhibitors may be sent additional circulars with information concerning the preparation and organization of the event. These Technical Regulations have been coordinated between the following exhibition companies and are published in a standard layout:

Deutsche Messe AG, Hanover
 Koelnmesse GmbH, Cologne
 Leipziger Messe GmbH, Leipzig
 Messe Berlin GmbH, Berlin
 Messe Düsseldorf GmbH, Düsseldorf
 Messe Frankfurt Venue GmbH, Frankfurt
 Messe München GmbH, Munich
 NürnbergMesse GmbH, Nuremberg
 Landesmesse Stuttgart GmbH, Stuttgart

For reasons of linguistic simplification and better comprehensibility, the generic masculine form of pronouns is used in the Technical Regulations. However, it always refers to persons of all gender identities and orientations.

Building law in Germany is governed by the law of the individual states. The respective implementation regulations may therefore vary for this reason and because of the different building situation that exists at the various other venues. Spielwarenmesse eG also reserves the right to make changes. The English text is legally binding.

1.1 Site regulations, extract from site regulations

Spielwarenmesse eG possesses the domiciliary rights to the exhibition site including the halls, in addition to the owner of the exhibition site, NürnbergMesse GmbH. The justified interests of the exhibitors shall be taken into account when exercising domiciliary rights.

1. The domiciliary rights with respect to the exhibitors and all third parties shall be exercised by personnel appointed by Spielwarenmesse eG, whose instructions must be complied with and who are to be granted access to the exhibition site at all times.
2. In the event of contravention of the site regulations or disruptive behaviour, Spielwarenmesse eG has the right to expel the persons concerned from the exhibition grounds and from its own car parks, withdraw their entrance tickets without compensation and have their vehicles towed away at the owner's cost and risk.
3. Spielwarenmesse eG has the right to check the storage compartments of vehicles and receptacles carried by persons, if required.
4. In case of theft of exhibits, the relevant person will be expelled from the site and the police informed. Spielwarenmesse eG reserves the

right to exercise its right to detain the relevant person on the exhibition grounds until the person's identity is established by the police.

5. Visitors to the event must leave the exhibition grounds at the end of the daily event times.
6. Compliance with instructions issued by the event director, event equipment director and security manager appointed by Spielwarenmesse eG is compulsory. The same applies to instructions issued by the security authorities, such as the fire brigade and public order office.

Exhibition emergency number (Security Control Unit):

- 7000 (internal; short dial on hall telephones)
- 0911 / 8606 7000

Please observe the currently valid version of the site regulations. They are mandatory for the entire premises of NürnbergMesse. They can be inspected at the on-site postings or at <https://www.nuernbergmesse.de/en/guidelines>.

1.2 Opening times

1.2.1 Start of assembly

Set-up starts on Monday, 20.01.2025 at 7:00 a.m. in all halls.
 Monday, 20.01. to Friday, 24.01.2025, 7:00 a.m. - 8:00 p.m.
 Saturday, 25.01. and Sunday, 26.01.2025, 7:00 a.m. - 10:00 p.m.
 Monday, 27.01.2025, 7:00 a.m. - 6:00 p.m.

For reasons of general safety on the exhibition grounds, the halls and the exhibition grounds as a whole will remain closed outside these times.

Please note that the final cleaning of the exhibition halls will take place before the start of the trade fair on Monday, 27.01.2025 from 6 p.m.. Boxes, packaging and decorative material left in the aisles from this time onwards will be considered as waste and removed.

The times that ServicePartners are present on site may differ from the general assembly and dismantling periods.

1.2.2 Duration of event

The fair is open from 9:00 a.m. to 6:00 p.m. on Tuesday, January 28, 2025 through Friday, January 31, 2025 and from 9:00 a.m. to 5:00 p.m. on Saturday, February 1, 2025. Exhibitors are admitted daily from 7:00 a.m. The stands must be manned by the exhibitors by not later than 8:45 a.m. The halls are open one hour prior to the official opening time and one hour after the official closing time. Also the outdoor area must be vacated for security reasons by not later than 7:00 pm during the fair. Exhibitors who for justified reasons need to work on their stands outside these times require special written permission from Spielwarenmesse eG.

1.2.3 Dismantling times

Dismantling begins on Saturday, 01.02.2025 at 5 p.m..
 Saturday, 01.02.2025 5 p.m. - 12 p.m.
 Sunday, 02.02.2025, 12 p.m. - 8 p.m.
 Monday, 03.02.2025, 7:00 a.m. - 8:00 p.m.
 Tuesday, 04.02.2025, 7:00 a.m. - 7:00 p.m.

Stands are not to be partly or fully dismantled or exhibits removed before the end of the event. Exhibitors contravening this rule are liable to a penalty amounting to 50 % of the invoiced exhibiting fee.

The exhibitor must completely remove all stand construction materials, all exhibition pieces and objects and also all its other exhibition goods by the end of the dismantling time announced for the event and restore the original condition of the exhibition space. Spielwarenmesse eG is entitled to have any exhibition goods remaining in the stands, gangways, foyers, or loading yards after the end of the dismantling time removed

and stored by the responsible forwarders (ServicePartner) at the expense and risk of the exhibitors or disposed of at its expense.

1.3 Responsible use of energy

Energy efficiency is a core value of the fair ground operator NürnbergMesse GmbH. It is their declared objective to be at the forefront of European trade fair companies in respect of energy efficiency. This is why they are committed to making all necessary resources available to achieve this goal.

Their energy efficiency programmes have to be characterized by a holistic approach involving ongoing improvement, technical development and efficiency of resources. They are continuously reviewing, evaluating and if necessary improving our energy management. They undertake to adhere to all applicable statutory requirements. In addition, they are committed to preventing waste of energy wherever it occurs and at all times and to using the latest environmental, safety and energy-saving technology that is economically feasible.

What can the exhibitor do to help?

- Switch off the stand lighting if there is sufficient daylight or lighting in the exhibition hall.
- When leaving the stand in the evening make sure to switch off the lights.
- Switch off printers, copiers and computers and do not leave them in standby mode.
- Use energy-saving LED lamps and energy-saving equipment and appliances (e.g. fridge with energy efficiency rating A+++)
- Whenever possible, re-close hall doors and gates, or keep them closed (even in summer to save cooling energy).

■ 2. Traffic in the exhibition grounds, escape routes, safety equipment

2.1 Traffic regulations

To ensure the smooth flow of traffic during the assembly and dismantling times and the event itself, the rules concerning the regulation and direction of traffic and any instructions issued by security personnel are to be strictly observed. The provisions of the German Road Traffic Act apply accordingly throughout the exhibition grounds and on all car parks owned by NürnbergMesse GmbH. The speed limit within the exhibition grounds is 20 km/h.

Vehicle access to the service areas between the halls is not permitted outside the straight lanes, as these areas have basements. Blocked areas and roads may not be driven on and the greatest possible consideration must be given to pedestrians. Unlawfully parked vehicles, trailers, containers, boxes and empty receptacles of any kind will be removed at the owner's expense and risk. The relevant information must be heeded.

1. Traffic and parking regulations: Parking in the immediate vicinity of the halls and especially in the loading yards and in front of the exits is prohibited for all types of vehicles for the duration of the event. During the assembly and dismantling periods, vehicles may only stop for loading and unloading at the designated parking spots. To prevent possible hindrance to the fire service, vehicles are to be removed immediately on completion of this work and can be parked on the designated parking areas during assembly and dismantling.

The **free parking areas** for trucks are located at **Poststraße 4**, only a few minutes' drive from the Nürnberg Exhibition Centre. Please follow the signs! Vehicle access to the loading yards during assembly and dismantling is only possible on payment of a **deposit of EUR 100** (exception: trucks of 7.5 t or more during dismantling). The deposit will be refunded if the vehicle leaves the loading yard within the time limits stated below.

The parking or entry permit must be completely filled out and mounted behind the windshield of the corresponding vehicle in a way that is clearly visible.

2. Time limits during assembly:

- 1 hour for loading and unloading cars and vehicles up to 2.8 t.
- 2 hours for loading and unloading vehicles of 2.8 t to 7.5 t.
- 3 hours for loading and unloading vehicles weighing more than 7.5 tonnes. (extension possible)

3. Time limits during exhibition:

- 1 hour for loading and unloading cars and vehicles up to 2.8 t.
- 2 hours for loading and unloading vehicles of 2.8 t to 7.5 t.

4. Last day of the exhibition (1 February 2025):

On the last day of the event, entry into the loading yards is possible to a limited extent due to the delivery of empty containers by the exhibition forwarding agents. You can drive in, considering the maximum length of stay mentioned below:

- From 2 hours after the end of the exhibition (7 pm) for cars and vehicles up to 2.8 t. (1 hour stay)
- From 3 hours after the end of the exhibition (8 pm) for vehicles of 2.8 t to 7.5 t. (2 hour stay)
- No entry possible for vehicles over than 7.5 t. Only possible from Sunday, 2 February 2025 at midnight (please note the Sunday driving ban!)

5. Time limits during dismantling (from 2 February 2025):

- 1 hour for loading and unloading cars and vehicles up to 2.8 t.
- 2 hours for loading and unloading vehicles of 2.8 t to 7.5 t.
- 3 hours for loading and unloading vehicles over than 7.5 t. (extension possible)

The stated access times may vary depending on the event and are notified at the entrance gates or by the exhibition management.

Vehicles may not enter the halls during assembly and dismantling.

Any exceptions to this rule must be agreed with Spielwarenmesse eG beforehand and are subject to approval.

Vehicles may only be moved in the halls at walking speed (maximum 6 km/h). Electric mini-vehicles (e.g. e-rollers, e-scooters, Segways, etc.) may not be operated in the halls. When used on the premises of Spielwarenmesse eG, such vehicles must meet all requirements for use on public roads. This includes, for example, a general operating license/individual operating permit, valid insurance protection, and a number plate/insurance plate.

Our ServicePartners may be permitted to be in the halls at times outside of the general assembly and dismantling times.

Further, detailed information **regarding parking and access arrangements** are available in the Online Service Center under **Information & Logistic**.

2.2 Escape routes

2.2.1 Fire brigade zones, hydrants

Essential fire brigade access routes and unrestricted movement zones marked by no stopping signs must be kept free at all times. Vehicles and objects parked on rescue routes and safety zones may be removed at the owner's cost and risk.

The marked fire-fighting equipment in the halls and outside area are not to be obstructed, obscured or made inaccessible. Hydrants are not to be used for filling purposes (e.g. containers, basins etc.).

2.2.2 Emergency exits, escape hatches, hall gangways

The escape and emergency routes are to be kept free at all times (see 2.6). Any doors located in escape and emergency routes must be easy to open from the inside over their full width. Escape and emergency routes, exit doors and emergency hatches and their identification markings must not be obstructed, built over, blocked, covered by hangings or rendered unrecognizable.

At no time may the escape and emergency routes in the halls be restricted by objects placed in or projecting into them.

In the event of contravention, Spielwarenmesse eG reserves the right to remedy the problem at the expense and risk of those responsible for the infringement.

Materials required for stand construction or exhibits delivered for immediate display in the stand space may be placed in the periphery of the hall gangway for a short time during the assembly and dismantling phases, provided the gangway widths required for safety reasons are still maintained and logistical interests are sufficiently taken into account. This requirement is regarded as fulfilled if the materials or exhibits are placed in a strip of maximum 0.90 m along the edge of the stand facing the hall gangway. Irrespective of the width of the hall gangway and the goods placed in the gangway, **a minimum width of 1.20 m must be kept free for access**. The areas in front of emergency exits and the junction areas of the hall gangways are to be kept clear of obstructions over their full width at all times.

The hall gangways must not be used to set up assembly areas or machinery (e.g. woodworking machinery, workbenches etc.). Spielwarenmesse eG may request immediate clearance of all hall gangway for reasons of logistics. **Instructions given by the security service must be followed.**

2.3 Safety equipment

Sprinklers, push-button fire alarms, fire extinguishing equipment, above-ground, underground or wall hydrants, smoke alarms, fire doors and self-closing doors and gates and other safety equipment, their markings and the green emergency exit signs must be accessible and visible at all times and must not be obstructed or made inaccessible.

2.4 Stand numbering

All stands will be marked with uniform stand numbers by the organizer if technically possible.

The stand numbers must be clearly visible and left on the stand during the entire time of the exhibition and may not be removed.

2.5 Security

The general supervision of the halls and outdoor area for the duration of the exhibition is provided by Spielwarenmesse eG. General supervision is also provided during assembly and dismantling times. Spielwarenmesse eG is authorized to carry out the necessary control and security measures.

If a stand security guard is needed, this must be ordered by the exhibitor himself using the Online Service Center (OSC). Stand guards may only be provided by the security company appointed by Spielwarenmesse eG.

Prevention of theft:

Incidences of theft in the Exhibition Center Nuremberg are comparatively rare. A continuing need to promote theft prevention measures is necessary to maintain this good reputation. This is achieved by Spielwarenmesse eG through security control and guarding measures.

These do not, however, apply to individual stands. Access to the halls during assembly and dismantling times is only permitted on display of special passes. Security staff will randomly check the authorization of persons involved in assembly and dismantling. Therefore, you should issue a certificate indicating the stand that the team is supposed to assemble or dismantle to the person responsible for the assembly and dismantling of your stand. Please support our efforts by observing the following instructions:

- **Assembly:** Your stand should not be left unsupervised after exhibits have been delivered following stand assembly. Although halls are locked and guarded on completion of assembly, an **additional stand guard is generally recommended**, also for the nights during the event. You should certainly lock away valuable goods at night. Safes and lockable display cases can be rented from the ServicePartners. Your stand cubicle can also be supplied with a lockable door (bookable at the Online Service Center section Stands, technical equipment & services -> Stand construction -> **Furniture and Carpet Hire**).
- **Dismantling:** Do not leave your stand until valuable exhibits have been loaded or handed over to the forwarding agent. Should this not be possible for special reasons, please order a stand guard for the time between the end of the event and the start of dismantling your stand.
- **Opening times:** Most thefts occur during opening times. Never leave your stand unattended, not even during the lunch period. Personal articles should be locked away. Especially exhibits liable to theft should be secured, e.g. with thin chains, nylon threads or presented in lockable display cases. The fair management of Spielwarenmesse eG will be pleased to advise on theft prevention matters. Spielwarenmesse eG reserves the right to impose special theft prevention conditions on individual exhibitors. Please also check your insurance against theft. We recommend taking out an exhibition insurance policy. Spielwarenmesse eG appreciates your cooperation.

2.6 Emergency evacuation

Spielwarenmesse eG or the responsible authorities may order the closure and evacuation of rooms or buildings for safety reasons. Persons present in these rooms or buildings must comply with this request (possibly by means of a speech announcement or the use of designated evaluation helpers) and evacuate the rooms or buildings via the marked emergency exits. Exhibitors must inform their staff of this procedure or if applicable draw up their own evacuation plans and display these on their stand. In this case, the closure of outdoor stand structures must be ordered and organized. Every exhibitor must see to it that its stand area/event area is evacuated immediately upon request.

■ 3. Technical details and equipment of halls and outdoor area

3.1 Hall details

Due to the different halls, this information is presented separately (see Instruction Sheet **i4.1 "Technical data of halls"**, and the permissible point loads).

3.1.1 General lighting, power supply, voltage

The general lighting during the event in the halls is at least 300 lux measured 1 m above the hall floor.

During assembly and dismantling, the exhibitor/stand builder must ensure an adequate level of light in the stand area. Available power supply and voltage on the exhibition grounds:

- Electrical system: TN-S
- Single-phase alternating current 230 Volt/50 Hz
- Three-phase alternating current 400 Volt/50 Hz

Connections up to 63 Amp are protected by Residual Current Devices (RCD). Tolerances to DIN EN 50160.

The following additional protective measures must be arranged and implemented by the exhibitor himself, if needed:

- Technical measures for interior lightning protection (surge arrester to absorb a lightning strike, for instance)
- Technical measures against network outage, network interruption (e.g. for continuation of processes, continued operation of equipment)

Spielwarenmesse eG shall not be liable for short-term network incidents.

3.1.2 Compressed air, electricity and water supply

In halls 1 – 12, 3A, 3C, 4A and 7A, compressed air, electricity and water for stands are usually supplied from the service ducts or shafts in the hall floor.

In halls with supports in the exhibition area (halls 3, 10.0, 10.1, 12), electricity can be supplied additionally from the terminal boxes located in the hall supports.

3.1.3 Communication facilities

Telephone, fax, data and antenna connections to the stands in all halls are supplied from the service ducts or shafts in the hall floor and must be ordered from the responsible ServicePartner. Exhibitors may only set up a **WLAN/WiFi network** if this has been expressly approved in writing by the Exhibition Services Department of NürnbergMesse GmbH (for further guidelines and conditions see Online Service Center section Stands, technical equipment & services -> Technical services & logistics -> **IT-Communication**).

As a general rule, the installation of beacons on the exhibitor's own stand area must be notified to and approved by Exhibition Services in writing (connectivity.services@nuernbergmesse.de). The transmission power must be reduced to the level that the played campaigns are only available in the stand area. Spielwarenmesse eG reserves the right to have the beacons de-installed if they cause interference with other services such as WLAN/WiFi or if the beacons are installed outside of your stand area or other requirements indicated in the Technical Regulations have not been met. The perpetrator will bear the costs of deinstallation.

3.1.4 Sprinklers

With the **exception** of halls **4A** and **7A**, halls 1 – 12 and 3A and 3C are equipped with sprinkler systems. These must have a safety clearance > 1.00 m at the top edge of the stand, exhibits or decorations for fire prevention and insurance reasons. **The minimum safety clearance** in closed rooms (e.g. conference rooms) is likewise **1 m**. A reduction of the stated safety clearance is always subject to review and approval by Spielwarenmesse eG (Exhibition Technology Department, see contact data in 4.2).

No heat generators may be placed in close proximity to sprinkler nozzles because the sprinkler nozzles usually open at a temperature of around 68°C and automatically release extinguishing water. This must also be taken into consideration when strongly focusing and heat-generating light sources are used!

3.1.5 Heating, ventilation

The halls are equipped with ventilation systems and heaters. Heating, ventilation and cooling are provided as needed during the event. This may sometimes lead to stronger air flows at the exhibition stand.

3.1.6 Failures

Any failures in technical supplies are to be notified to the fair management without delay. Spielwarenmesse eG shall not be liable for any losses or damage caused by such failures and due to ordinary negligence.

3.2 Outdoor area

The outdoor area of NürnbergMesse consists of paved or asphalted traffic areas and uneven, mostly non-compacted ballast lawn areas or grown lawn areas.

During event opening times, the outdoor area is illuminated by general road and path lighting after dark. The necessary service connections are available at irregular intervals.

Please pay attention to Item 4.8 Outdoor area when making your plans. Generally, excavations and ground anchoring (e.g. ground stakes) are not admissible outdoors.

If you do not comply with these stipulations you will generally be responsible for all loss and consequences in the event of damage to piping and cables (even if you have received special approval from Spielwarenmesse eG). All material brought to the outdoor area must be removed and the area restored to its original state.

■ 4. Stand construction regulations

4.1 Stand safety

Stands, including all equipment, exhibits and advertising media, are to be constructed with such stability as to pose no danger to public safety and order, especially to life and health.

The exhibitor is responsible for structural stability of all structures and exhibits and must provide proof of this if necessary. This also applies during assembly and dismantling.

Any threats to adjacent escape routes or stand areas must be ruled out by means of appropriate advance planning and the careful performance of work on site.

The load-bearing capacity of all components and materials must be assured. The overall stability must be assured by means of sufficiently stable materials and frictional connections. Pressed wood materials such as chipboard or fibreboard according to DIN EN 312-1 (P1, P2 and P3) may not be used for structurally supporting stand constructions.

Standing construction elements or special constructions (e.g. free-standing walls, tall exhibits and tall decorative elements, LED walls) that may tip over must be loaded with a minimum **horizontal equivalent distributed load of q_h** :

- $q_{h1} = 0.125 \text{ kN/m}^2$ ($0 < h < 4.0 \text{ m}$)
- $q_{h2} = 0.063 \text{ kN/m}^2$ ($h > 4.0 \text{ m}$)

The reference area here is the respective face area.

The certificates issued for this purpose (verifiable structural analyses) are to be submitted at the request of Spielwarenmesse eG.

In justified cases, Spielwarenmesse eG reserves the right to have the stand safety checked on site by a structural engineer at extra cost.

Stabilizing against neighboring stands or existing structures is not permissible. Stabilization by means of suspensions from the hall ceiling is also not permissible.

4.2 Approval of stand construction

Assuming that the technical regulations of the respective event have been observed in the design and construction of the stand, it is not necessary to submit drawings for review and approval in the case of single-storey stands.

For a **stand space of 80 m²** or more **stand plans** in electronic form (.pdf) must be submitted for official examination to Spielwarenmesse eG **without further request** by not later than 30 November 2024.

We are pleased to offer this free service also for smaller spaces. Spielwarenmesse eG's right to claim stand plans from each single exhibitor keeps unaffected. Please note that stand drawings can only be considered if they are received by 30 November 2024. No legal claim to processing exists for stand plans submitted after this date. Please note that neither Spielwarenmesse eG nor NürnbergMesse GmbH can provide approval for plans with respect to protection against infection. The protection against infection at the booth is the exhibitor's responsibility.

Furthermore, all other stand structures, mobile stands, special structures, etc. are subject to approval, see Items 4.2.1 and 4.2.3.

For technical approval procedures, please contact Spielwarenmesse eG: Fair Management Department, standbau@spielwarenmesse.de

Time period for technical approvals:

Especially in the case of complicated approval processes, e.g. including additional official approval or inspections, please allow a processing time of up to 42 days after the complete documentation has been submitted to Spielwarenmesse eG. Processing within 14 days is only possible in exceptional cases providing we have the complete documentation and there is little complexity involved. The period specified applies to the issue of the approval and does not represent the event date. In the following paragraphs we use the phrase "by the specified deadline". Please submit all documents for checking and approval in electronic form only (.pdf).

Definition of "technical approval":

Even if the technical approval has been given by Spielwarenmesse eG, this does not exempt you in principle from adhering to the Technical Regulations, unless a departure from the Technical Regulations was specifically part of the technical approval.

4.2.1 Inspection and acceptance of structures requiring approval

Dimensioned stand plans to a scale of not less than 1:100 with layout plans, views and if necessary seating plans must be submitted to Spielwarenmesse eG for approval by the specified deadline (see Item 4.2). The stand construction is not permitted until the plans have been stamped as authorized.

For approval of:

- multi-storey stand structures
- outdoor buildings (e.g. temporary structures). Please note Item 4.8 Outdoor area.
- special constructions (show trucks, promotional vehicles, promotional trailers, climbing walls, carnival rides, containers, moving parts, etc.)
- cinemas or lecture rooms larger than 100 m²
- performance/stage area

- podium areas and walkable structures from a height of 0.20 m
- LED walls/video walls and their substructures or rigging materials

The following documents must be submitted in German in electronic form (.pdf) by the specified deadline (see Item 4.2):

- a) Audited or auditable structural analysis to German standards
- b) Building specification with details of materials to be used (including certificates, where applicable)
- c) Stand construction drawings in a scale of 1:100 (floor plans, views, sections), construction details in a larger scale
- d) Escape route plan with evidence of lengths and widths of emergency routes
- e) Items a), b) and c) are not required if a valid site inspection log/type test is submitted
- f) Seating plans, if applicable escape and emergency route plan (cinema and lecture rooms)

In the case of LED walls/video walls items d) and f) do not apply.

The cost of the approval procedure will be charged to the exhibitor/stand construction company.

4.2.2 Vehicles and containers

Vehicles and containers used as exhibition stands in the halls and throughout the exhibition grounds and car parks must be registered and require written approval. When installing vehicles, containers and tents etc. within the halls, it may be necessary depending on their purpose, condition and location, to equip them with safety lighting, a sprinkler system, smoke/differential heat detectors (connected to the NürnbergMesse fire alarm system) or fire extinguishers. More detailed information is available in 4.4.2.

Show and stage trucks in the outdoor area with extendable or sub-mountable trailer parts, extensions or stage elements also fall within the scope of application of the so-called "temporary structures" and must be additionally notified to the relevant authority and checked by it where applicable.

4.3 Construction heights

The minimum construction height is 2.5 m. The maximum construction height is 4.5 m.

The backs of any construction elements (e.g. partitions, advertising media, banners, company logos, etc.) facing neighbouring stands must be white, clean and impeccable in appearance above a height of 2.5 m and must not contain any text or graphics. Text and graphics are permitted if there is a minimum distance of 2 m to the neighbouring stand on each side of the construction element with heights from 2.5 m to 4.5 m.

Installations and structures must not impair the functioning of the sprinkler system. Information on the necessary safety distances can be found in Item 3.1.4 **Sprinkler system**.

4.4 Fire prevention and safety regulations

4.4.1 Fire protection

All materials brought into the trade fair stand, including exhibits, must be the subject of a risk assessment for the stand. Spielwarenmesse eG reserves the right to request this risk assessment and where applicable demand additional compensation measures. It is recommended that exhibitors contact the Event Technology Department in advance in cases of doubt concerning fire protection systems (see contact under 4.2).

The halls are equipped with fire alarm and automatic fire extinguishing systems. If these fire protection systems are impeded due to stand structures, the release of gases, activities that generate fire, smoke and heat, appropriate mitigating measures are necessary and are to be agreed with Spielwarenmesse eG beforehand (see 4.2). Safety equipment such as fire extinguishers, fire alarms, fire hydrants and associated signage, as well as the emergency exit pictogrammes in the hall, must not be built over or otherwise obstructed or concealed.

The Nürnberg Public Affairs Office (Ordnungsamt) is responsible for events governed by the Trade Regulations. The technical acceptance of the event is carried out by a representative of the Nürnberg fire brigade, a representative of the Public Affairs Office and a representative of the operator (person responsible for event technology) and if necessary a representative of the organizer.

In all cases of doubt concerning fire prevention matters, exhibitors are recommended to contact Spielwarenmesse eG.

The trade inspectorate and regulatory authorities, police and fire brigade, the fire safety officer, the event director, the security manager, or the event equipment director of NürnbergMesse and representatives of NürnbergMesse (Exhibition Technology Department) and the organizer's representatives are entitled to issue instructions as part of safety

regulations. Their representatives are to be granted access to the safety equipment and technical facilities at all times.

4.4.1.1 Stand construction and decoration materials

In general, no materials that are readily flammable, drip on burning or produce toxic gases, or other smoke-forming materials may be installed. This prohibition also includes **thermoplastics** e.g. rigid polystyrene foam (**PU foams, Styropor, Styrodur, EPS, XPS** etc.) and **PVC**. The materials listed here may also not be used in substructures, insulations or as fillers. On a case-to-case basis, special requirements (like non-flammability) may be imposed on load-bearing structural parts for reasons of safety.

Structurally necessary and/or load-bearing fixings may only be made of non-flammable fixing materials. Decoration materials, embellishments, furnishings and also floor covering, banners and curtains must as a minimum meet the categories flame retardant (B1) and must not drip on burning, as per DIN 4102-1 with limited smoke development and/or as per EN 13501-1 as minimum Class B/C – s2, d0. A test certificate detailing the construction material class, fire, smoke and droplet-forming behaviours of the material used must be kept at the exhibition stand from the assembly period onwards. In addition, samples of the materials used must be kept on hand for a fire test on site. In specific cases, decoration materials with a normal combustibility rating may be used in certain areas if the method of installation (e.g. display cabinets) provides adequate protection against catching fire. Cuttings of trees and plants may only be used for decoration purposes in a green condition. Should they dry out during the event and become easily ignited (DIN 4102 B3), they must be removed. Trees should be free of branches up to approx. 0.50 m above floor level. The use of deciduous and coniferous trees is permitted only if they have moist, potted roots.

Natural materials with fibrous surfaces containing resin or oil, such as palms, birch, bamboo, reeds, hay, straw, bark mulch, wood chips or similar materials do not meet adequately the above-mentioned requirements and are not permitted.

Absorbent natural materials in natural fibers such as jute bags, woven and knitted fabrics or similar do not generally have “low flammability” and may only be used if treated with a suitable flame retardant impregnation.

Construction and decoration materials such as **wooden pallets, wooden boxes or baskets** whose design and surface properties represent a high fire load are generally not admissible. Any fire protection measures such as treating the surfaces and additional fire-proof coatings must be registered and agreed on beforehand to Spielwarenmesse eG using form “fire prevention”. Further requirements for glass and acrylic glass materials are specified in 4.4.3.

“Flame resistant” properties can be achieved retrospectively for some of these materials by treating them with an approved flame inhibiting agent. A certificate confirming that the material is flame resistant or that impregnation has been carried out in accordance with the regulations must be available for inspection on the stand at all times.

4.4.1.2 Exhibition and presentation of motor vehicles

Motor vehicles may only be exhibited and presented in the halls after registration and approval by Spielwarenmesse eG (see 4.2), stating the number and type of vehicles involved. For all vehicle types a sufficient number of suitable hand-held fire extinguishers (to EN 3) must be kept in readiness at the exhibition stand. Spielwarenmesse eG reserves the right to take additional measures. The exhibitor/event organizer must prevent the unintended or wilful moving of vehicles by third parties. Keyless systems (transmitters) must be kept out of range.

Vehicles must be positioned in such a way that no vehicle parts, attachments, vehicle doors or other movable components protrude into the hall aisles. Vehicles must be externally prevented from rolling away on a statically suitable subsurface (hall floor, exhibitor floor, pedestal, etc.).

Vehicles with internal combustion engines

The content of vehicle fuel tanks is to be reduced to the amount necessary for driving into and out of the hall (the low fuel warning lamp must be on); the tank cap is to be locked. Powering the vehicles via the starter battery is possible if it can be ensured that no dangerous gases will be produced.

Combustion engines may not be demonstrated in operation in the halls. Fuels must not be stored at the stand. The refuelling of vehicles in the hall is prohibited.

Vehicles with electric or hybrid motors

In the case of hybrid vehicles the tank must also be largely empty and closed. For electric vehicles, the charge status of the vehicle battery

must be reduced to an uncritical level necessary for driving into and out of the halls and for presentation purposes. Charging processes in the exhibition halls are subject to review and approval by Spielwarenmesse eG (Exhibition Technology Department, see contact data in 4.2). Rescue cards must be kept on hand for electrically powered vehicles.

Vehicles with gas-powered engines

For vehicles with internal combustion engines, the fuel tank level must be reduced to the necessary level for driving into and out of the halls. The low-fuel warning lamp must be activated. Rescue cards must be kept on hand for vehicles with internal combustion engines.

Vehicles with fuel cells or alternative drives

Vehicles with fuel cells or other types of drive are considered separately. However, it should generally be noted that the tank content must be reduced to the amount necessary to drive in and out (the reserve light on the tank display must be on).

Depending on the event and the exhibition location (e.g. foyers, entrance areas, fire brigade access routes, or assembly rooms), additional safety measures including the inertization of the fuel tank, the disconnection of the battery or batteries, and/or the posting of security guards may be required.

4.4.1.3 Explosive substances, munitions

Explosive substances are governed by the German Explosives Act, as amended, and may not to be exhibited at trade fairs and exhibitions. This also applies to munitions, rounds and projectiles as defined in the German Firearms Act and to pyrotechnic objects.

4.4.1.4 Pyrotechnics

Pyrotechnic demonstrations require approval of Spielwarenmesse eG. Spielwarenmesse eG is under no obligation to grant its approval. If pyrotechnic effects are to be used on the NürnbergMesse grounds, the exhibitor/organizer must obtain approval from the responsible Public Order Office, the Trade Inspectorate and the Nuremberg fire brigade not later than 28 days before the actual date of the event. A copy of the approved application is to be submitted to NürnbergMesse by not later than 14 days before the start of the event. The license for the articles is shown on the respective packing unit. Instructions must also be printed on the package in English.

Pyrotechnic objects without a certificate of conformity or fireworks of Categories II, III or IV are not approved. Pyrotechnic objects may only be used when they have a **CE label and a registration number**. Proof of the holder of the license and certificate of competence is to be submitted to Spielwarenmesse eG (see Instruction **Sheet i4.5 “Pyrotechnic displays/activities involving fire hazards”**).

4.4.1.5 Balloons

The use of balloons filled with safe inert gas in the halls and outdoor area must be approved by Spielwarenmesse eG. Insofar as the use of balloons has been approved by Spielwarenmesse eG, they may only be filled with non-flammable and non-toxic gases and must be structurally firmly anchored within the city limits. In addition, the maximum construction height specified for each event must be observed. Depending on the balloon size, placement and installation type, the fire protection requirements of Item 4.4.1.1 must also be observed. The distribution of gas-filled balloons is basically not permitted.

4.4.1.6 Flying objects

The use of flying objects (e.g. drones, quadrocopters, airships etc.) is generally not allowed in the halls and outdoor areas. Exceptions require the prior written authorization of the relevant authorities and the written approval of Spielwarenmesse eG (see contact details in 4.2).

Insofar as the use of the flying objects has been authorized by Spielwarenmesse eG, the requirements pursuant to the **German Aviation Act** (LuftVG), the **German Aviation Regulation** (LuftVO), the **German Aviation Licencing Regulation** (LuftVZO), the **German Act on the Adaptation of National Regulations to the Commission Implementing Regulation (EU) 2019/947 on the Rules and Procedures for the Operation of Unmanned Aircraft** (as amended in every case) and the protection of personal rights and copyrights of third parties must be strictly observed. This includes specifically the proof of corresponding owner's liability insurance and the necessary operator certification. In some cases the use of airspace may require permission from the relevant aviation authority. In addition, all flying objects with a take-off weight of more than 0.25 kg must bear the name and address of the owner using a permanent, fireproof marking method. In general, it must be remembered that parts of the grounds of Spielwarenmesse eG are within the air

traffic control area of NUREMBERG AIRPORT and in the catchment area of critical infrastructure, so that there is a general flight ban. The unrestricted operation of flying objects above gatherings of people is prohibited in principle. By way of derogation, structural partitions may be necessary to close off the flying area on all sides from freely accessible areas in order to demonstrate or operate flying objects following approval by Spielwarenmesse eG. The necessary measures are to be agreed on beforehand with the specified contact persons and are subject to approval.

4.4.1.7 Fog machines

The use of fog machines or hazers is subject to arrangement with Spielwarenmesse eG. Spielwarenmesse eG will charge the organizer or responsible entity for the cost of substitute measures if firefighting appliances must be deactivated before operating a fog machine. The organizer and/or person responsible will be charged for the cost of calling out the fire brigade and the subsequent costs resulting from the interruption or cancellation of the event if the fire alarm system is set off without prior consultation with Spielwarenmesse eG. Further information can be obtained from Instruction Sheet **i4.6 "Use of fog machines"**. In general, it must be ensured that adjacent exhibition stands are not impaired by the use of fog machines or hazers.

4.4.1.8 Ashbins, ashtray, smoking ban

There is a **total smoking ban** in all the buildings, halls, stands and empty areas on the fair ground during assembly, the exhibition itself and dismantling.

Please use the designated outdoor smoking areas.

If the smoking ban has been lifted for the stand or parts of the stand in the outside area, an adequate number of ash bins or ashtrays of non-combustible material must be provided and emptied at regular intervals.

4.4.1.9 Waste and recycling material containers

Bins provided on the stands for waste and recyclable materials are to be made of non-combustible materials only. These bins are to be emptied regularly and not later than every evening after closing time. Should larger quantities of combustible materials accumulate, these are to be disposed of several times a day. Flammable waste or readily flammable materials and waste like wood shavings, wood scraps, sawdust and the like must be kept in sealed containers. If such waste occurs during product demonstrations it must be ensured that it can be stored in closed containers immediately after the demonstration. The work areas must be designed so that such waste does not occur on traffic areas. If **wood is machined during the exhibition** and/or **sawdust extractors or silos are used**, the rules set out in Items 5.2, 5.2.1 and 5.2.2 must be observed. The use of the waste described above for decoration purposes is prohibited. Waste disposal can be ordered at extra cost from the ServicePartners of Spielwarenmesse eG using the Online Service Center.

4.4.1.10 Spray guns, solvents

The use of spray guns and substances and paints containing solvents is prohibited in all halls.

The use of

- combustible liquids, including for cleaning purposes
- materials releasing toxic vapors and
- substances hazardous to the environment

is prohibited.

4.4.1.11 Abrasive cutting and all other work using naked flame

All welding, cutting, soldering, thawing and abrasive cutting work must be notified to Spielwarenmesse eG in writing for approval before commencement of the work. The approval of this work is granted by Spielwarenmesse eG in the form of a permit for work involving dust, smoke, welding and heat. The adjacent area is to be adequately protected from hazards during this work. Suitable fire extinguishers and VdS approved fire blankets must be available for use in the direct vicinity. In addition, a fire safety guard can be arranged at extra cost via the Online Service Center. Due to the particular risk potential during assembly and dismantling, we recommend designing your stand so that such hazardous work is avoided or can at least be done outside the hall.

The work permit can only be issued on time if the relevant application is submitted in good time to Spielwarenmesse eG.

Actions involving fire hazards or work involving heat during the event require the written approval of Spielwarenmesse eG and are only permissible when they are absolutely necessary for the presentation of exhibits. Spielwarenmesse eG is under no obligation to grant its approval.

4.4.1.12 Empty packaging/storage of materials

The storage of filled and empty packaging of any kind (e.g. packaging and packing materials), waste or remnants inside or outside the stand, in the halls or in the loading yards is not permitted. This also applies to storage under stages, podiums, stands, and stairways or behind stand construction walls. Empty packaging is to be removed without delay.

Collection and storage can be ordered at extra cost from the ServicePartners of Spielwarenmesse eG using the Online Service Center. If the exhibitor does not comply with a request to remove material stored in contravention of the rules or does not remove waste, remnants, filled or empty packaging immediately when asked, Spielwarenmesse eG reserves the right to have it removed at the cost and risk of the exhibitor.

4.4.1.13 Fire extinguishers

At least one fire extinguisher conformant with DIN EN 3 (see Instruction Sheet **i4.7 "Fire extinguishers"**) with at least 12 extinguishing agent units (EAUs) must be kept on hand on exhibition stands/event areas larger than 100 m² during assembly and dismantling and the event itself. Only water or foam extinguishers with an up-to-date test label may be used. Powder extinguishers are only admissible for demonstrations using combustible gases. Cleaning costs resulting from the use of powder extinguishers will be charged to the perpetrator.

It is recommended that, as far as possible, a water or foam extinguisher be used, since if a powder extinguisher is used, there is a risk that adjoining stands may need to be cleaned afterwards as the emerging jet of powder cannot be controlled. These costs will be charged to the party causing the need for cleaning. In general, a suitable fire extinguisher must be available for electrical distribution boxes with a total power rating of 6 kW. To ensure the easy handling of the fire extinguishers, we recommend that you choose fire extinguishers that do not exceed a weight of 12 kg per extinguisher. Suitable fire extinguishers (kitchens: Class A, B, F, storage areas Class A, B) are to be available at stands with kitchens and storage areas.

In multi-storey stands, a fire extinguisher must additionally be kept in each stairway on the second storey. All fire extinguishers must be placed in highly visible and continuously accessible locations in such a way that they cannot topple over, and must be labelled in accordance with ASR A1.3. Suitable tested fire extinguishers can be rented via our ServicePartner Wörnlein (see Item 4.4.1.1). Spielwarenmesse eG reserves the right to charge for used or damaged fire extinguishers taken from wall hydrants.

4.4.2 Stand roofing

The ceilings of all stands in halls equipped with sprinklers must be of open design to avoid impairing the operation of the sprinklers. Ceilings are regarded as open if not more than 30 % (CEA 4001 S) of each square meter of the ceiling area is closed. This also applies to conference rooms, catering areas and reception rooms. Sprinklercompatible ceiling fabrics are permitted up to a covered area of no more than 30 m² if they only have one layer and if the vertical distance from the sprinkler head is at least 1.0 m. Alternatively, the sprinkler compatibility can be demonstrated by means of a valid VdS certificate.

In general, the closed area of single-storey stands is not to exceed 30 m². For closed areas larger than 30 m², a suitable number of sprinklers and, in smoke-monitored halls (H4A, H7A, H11), smoke or differential heat detectors must be installed by the responsible ServicePartner. Exceptions are possible in individual cases. Several closed ceiling areas up to 30 m² in one exhibition stand are possible, provided that there is a minimum distance of 3.00 m between the individual ceiling areas. So as not to exceed the maximum surface area of 30 m² when adding up several ceiling areas, a distance of minimum 1.50 m to the stand limits must be observed. Any reduction of the 1.50 m distance (e.g. to passageways and hall ways) has to be approved by Spielwarenmesse eG.

If the stated minimum distances can-not be maintained (also across stands) and if the addition of the closed ceiling area would cause the maximum permissible area to be exceeded, the perpetrator will bear the costs for necessary compensation measures. This also applies explicitly to affected adjacent stands!

The ceiling areas, like sprinkler gauzes and fabrics, must be categorized as a **minimum as flame retardant (not readily flammable)** (class B1) and **must not drip on burning**, as per DIN 4102-1 with limited smoke development and/or as per EN 13501-1 as minimum class B/C – s2, d0.

A test certificate on the construction material class, fire, smoke and droplet forming behaviors of the material used, and/or the VdS certificate, must be kept at the exhibition stand from the assembly period

onwards. In addition, samples of the materials used must be kept on hand for a fire test on site.

Room and areas with a heightened risk of fire (e.g. kitchens, storage rooms, cloakrooms, utility rooms, etc.) must have open ceilings. In exceptional cases, sprinklers, and in smoke-monitored halls VdS-certified smoke or differential heat detectors, must be installed by the responsible ServicePartner. Sprinkler-compatible ceiling materials with a current VdS test certificate are admissible.

In the case of rooms, tents, containers, vehicles and similar enclosed on all sides and with closed ceiling areas, it may be necessary, depending on their purpose and condition, to fit them with a sprinkler system, smoke or differential heat detectors, even if the ceiling area is less than 30 m². In addition, it must be ensured that these enclosed rooms/areas are equipped with suitable emergency lighting (see Item 5.3.5). Such installations and rooms must be inspected and authorized in advance by Spielwarenmesse eG (see contact details 4.2). All fully enclosed reception and lecture rooms that have no visual or acoustic contact with the hall must be fitted with appropriate alarm systems (see Item 4.4.4).

More information on sprinkler-compatible ceiling materials is provided in the Instruction Sheet **i4.2 "Installation of sprinkler-compatible ceiling materials"**.

For multi-storey stands see Item 4.9.2.

4.4.3 Glass and acrylic glass

Only safety glass suitable for the intended purpose may be used.

For glass structures (floors, balustrades, facades and ceilings) please observe Instruction Sheet **i4.8 "Glass in stand construction"**.

Appropriate stability verifications and datasheets for the safety glass must be kept in the stand.

The edges of glass sheets must be finished or protected to reliably prevent risk of injury. Stand components made of glass only are to be clearly visibly marked at eye level.

Wall panels or supports in glass have to be designed to be loadfree, i.e. roof structures or similar projecting elements have to be supported on beams or walls and structurally stable, without the loads being carried by glass panes or supports used (including glass cabinets).

Acrylic glass must at least meet the requirements of DIN 4102, B1 or DIN EN 13501, B/C – s2, d0 and must **not** drip on burning (see Instruction Sheet **i4.8 "Glass and acrylic glass"**). In addition, the acrylic glass must generate minimal smoke (s1 or s2 to DIN EN 13501).

4.4.4 Reception rooms/inner rooms

All fully enclosed reception and audience rooms that are accessible to visitors (e.g. booths, conference rooms, offices, and the like) and **have no optical and acoustical contact to the hall** must be equipped with an optical and acoustical alarm system to ensure that an alarm can be sounded in these rooms at any time. Alternatively, **fully enclosed rooms** that are accessible to visitors (e.g. booths, conference rooms, offices, and the like) that **have acoustic contact to the hall** can be provided with a line of sight into the hall via the exhibition stand.

The **visual contact** should be designed so that when anyone is in the enclosed room they still have an unencumbered view when sitting or standing. A window 0.20 m wide and 0.80 m high is recommended as a suitable size for the field of vision. Small window areas at head level (e.g. so-called portholes) do not meet the stated requirements and are therefore not permitted.

If it is not possible to see the hall via the stand (because the view is blocked by structures, walls, exhibits, etc.), technical measures must be taken to compensate for this. This also applies to exhibition areas in which the line of sight to the hall is blocked in certain areas by exhibits, installations or structures. Technical compensation measures must be notified to and approved by NürnbergMesse (Exhibition Technology Department, see the contact data in Item 4.2) in advance. In rooms enclosed on all sides, care must be taken to ensure an adequate level of light to allow for safe orientation also in case of a power outage. If necessary, suitable **safety lighting** must be provided (see Item 5.3.5). Technical measures to compensate for a restricted line of sight must be notified to the Spielwarenmesse eG in advance and are to be approved by this department.

Reception rooms and lecture rooms etc. with a **floor space exceeding 100 m²** or that accommodate **more than 200 people** (see Item 4.2.1), require special approval. **Seating** is to be provided in accordance with § 10 of the Venue Regulations (VStättV) and drawn into an escape and emergency route plan in accordance with § 32 VStättV.

Trapped rooms (rooms that can only be left via other rooms) are not permitted.

4.5 Exits, escape routes, doors

4.5.1 Exits and escape routes

The distance from any point on a stand space to a necessary hall gangway must not exceed 20 m walking distance (§7 VStättV).

This also applies to a multi-storey stand.

Reception rooms with a floor space exceeding 100 m² must have at least two exits to escape routes and these must be positioned opposite each other and as far apart as possible.

The following minimum number and inside widths of escape routes (exits, corridors) are to be provided:

- up to 100 m² room area and less than 100 people:
1 escape route, 0.90 m wide
- over 100 m² room area and less than 200 people:
2 escape routes, each 0.90 m wide
- more than 100 m² room area and more than 200 people:
at least 2 escape routes each 1.20 m wide

Escape route widths are to be graduated only in 0.60 m increments per 100 people. The escape and emergency routes are to be permanently marked as per ASR 1.3 and/or DIN EN ISO 7010, DIN EN 1838 and DIN 4844-1 (German Workplace Regulations).

It must be possible to open the doors of these exits from the inside in the escape direction at all times during the event and these doors must not protrude into the hall gangway. A suitable recess must be provided in all cases.

4.5.2 Doors

Swinging doors, revolving doors, code-operated doors and sliding doors and emergency may not be used along escape routes. Doors and door systems in escape and emergency routes must open smoothly at all times to their full width from the inside to the escape and may not have door sills or stumbling hazards. Escape doors must not impair or restrict emergency routes or hall gangways.

4.6 Platforms, ladders, stairs, catwalks

Areas generally accessible to pedestrian traffic and directly adjacent to areas 0.20 m lower are to be enclosed by **railings/balustrades**. They must be at least 1.10 m high and consist of at least a top band, centre band and bottom section (maximum separation 0.35 m). Safety devices must be suitably designed to prevent the risk of objects being placed on them and falling into areas below. The separation between the parts of the railings must not exceed 0.12 m in any direction.

For **platforms**, a verifiable structural analysis with **load capacities** to DIN EN 1991-1-1/NA:2010-12 Table 6.1DE [Cat. C] is to be provided as detailed below and submitted to Spielwarenmesse eG by the specified deadline (see 4.2):

q_k ≥ 3.0 kN/m² Perpendicular load for limited use by trade fair visitors.

q_k ≥ 5.0 kN/m Perpendicular load for freely accessible areas and/or unrestricted use.

q_k = 1.0 kN/m Horizontal load at rail height of the balustrade.

H = ∑q_k/20 q_k = Perpendicular load. To ensure sufficient longitudinal and transverse rigidity, a **horizontal load H** must be set at the highest floor height.

Staircases and stair landings must always be designed for a load (Cat. T2) of: **q_k = 5.0 kN/m²**.

Costs will be incurred for the inspection and approval of this special structure and will be billed to the exhibitor/stand builder.

Accessible single-level platforms must not be higher than 0.20 m.

The area underneath platforms and podiums must not be used for storage. They must be designed to be fire load free. Hollow spaces of platforms with a height of less than 0.20 m, can be excepted from monitoring by the fire alarm system. Hollow spaces of platforms with a height of more than 0.20 m, which accommodate an automatic turntable, or an accumulation of cables and/or electrical distributors, must be monitored by VdS certified smoke detectors.

Installation must be done by the Spielwarenmesse eG ServicePartner. Moving parts such as escalators or revolving stages are subject to the prior approval of Spielwarenmesse eG.

All **staircases** must be constructed according to DIN 18065 and must have a clear width of at least 1.20 m. Essential stairs and stairs used for general visitor circulation must have closed steps. The risers may not be higher than 0.19 m and the tread width may not be less than 0.26 m. When determining the tread width, it should be ensured that "undercutting" (e.g. with risers) cannot be added on. Furthermore, in designing the undercutting, care must be taken to ensure that the heel is not caught when going down stairs.

With stairs, an **intermediate landing** must be provided after 18 steps. The depth of the landing should be a multiple of the step dimension. An uneven number of steps should be taken as a basis. Stairs may not begin immediately behind a door. There must be a sufficient landing (min. depth 1.0 m) between the staircase and the door. **Winding or spiral stairs** within emergency exits and escape routes are not allowed. Stairs must have **handrails** on both sides. Stairs more than 2.40 m wide need central handrails. Handrails must be continuous and allow for a firm grip. Handrails must be designed in such a way as to exclude any risk of accidents and allow for a firm grip. The ends of the handrails must be designed in such a way that it is not possible to hang from them or slide off of them.

Ladders, stairs and catwalks must conform to the accident prevention regulations (German DGUV Information 208-016).

4.7 Stand design

4.7.1 Appearance

The exhibitor is responsible for the design of the stand, which must be in keeping with the typical exhibition criteria for Spielwarenmesse®. Spielwarenmesse eG is entitled to specify changes to the stand design in this connection. The design of stands and presentation of exhibits must ensure an open approach to customers.

At least 70 % of the sides of the stand facing gangways must be open. Stands that adversely affect the overall image of the fair or the hall will not be accepted by the fair organizer. The same applies to inadmissible advertising. The exhibitor is responsible for laying a uniform covering on the floors of the stand.

The stands must be joined as closely as possible and without loss of space. The allocated stand space must not be exceeded. If the exhibitor or his appointed stand construction company fails to comply with the stand construction regulations or other legal provisions, the exhibitor shall be liable for all damage resulting from the violation of these provisions. The extent of damage will be determined by an assessor appointed by the fair organizer. The assessor's findings shall be binding on both parties.

Walls bordering visitor gangways should be made more attractive by installing glass showcases, niches, displays, etc. Rear walls of stands that exceed a height of 2.50 m and are adjacent to neighboring stands should have a single, neutral and light colour and be kept free of installations to avoid adversely affecting the design of the neighboring stand. Fittings and structures on corners of the stand area that border on visitor walkways must be designed in such a way as to exclude any risks. In particular, **stumbling hazards** in the form of platforms, double floors or raised floors must be avoided at freely accessible stand corners, especially in the case of **tapered stand areas**.

The use of products made by exploitative child labor within the meaning of ILO convention 182 is prohibited for stand design and equipment.

4.7.2 Verification of rented area

The rented area is marked out by Spielwarenmesse eG. Every exhibitor is obliged to obtain information about the location, dimensions and possible structures in this area by visiting the site. The stand limits must be strictly observed. The exhibitor must expect minor deviations in the size of the stand. These are due to variations in the thickness of the stand partition walls and may be up to 5 cm in front and depth. The corners are marked. No responsibility can be accepted for the correctness of the dimensions. The supply points inside the stand space must remain accessible. Any pillars, wall projections, stand partition walls and fire-fighting equipment are part of the allocated stand space.

The supply grid for electricity, compressed air, water and telecommunications is shown on the hall plans sent to exhibitors. The supply ducts are not to be opened by exhibitors or obstructed by stand structures.

The stand boundaries must be adhered to. Lighting fixtures or signs must not project out into the halls from the stand boundaries.

Machines and other exhibits must be positioned so that there is enough space for exhibitors to demonstrate them on their own stand area. Provision must be made for the necessary safety barriers or enclosures in this conjunction. Every exhibitor/stand builder is obliged to verify the proper condition of the stand area before starting to assemble the stand. Any damage must be notified to the Security Control Unit (see Item 1.1) without delay before starting to build the stand. Any such deficiencies not recorded will be rectified after the event at exhibitor's cost.

4.7.3 Interference with building fabric

Hall parts and technical equipment must not be damaged, soiled or altered in any other way (e.g. drilling, nails, screws, glue). Painting, wallpapering and the use of adhesives are also prohibited.

Hall parts and technical equipment must not be used to support loads from stand structures or exhibits.

However, hall pillars and supports inside the stand space can be adapted, provided they are not damaged and the permissible construction height is not exceeded. Installations on the hall pillars, walls and technical equipment must be freely accessible. If necessary inspection ports must be provided by the exhibitor building the stand. If floor anchors are necessary please observe 4.7.4.

4.7.4 Hall floors

Carpets and other floor coverings are to be laid so as not to cause accidents and must not extend beyond the stand limits. Floor coverings in exhibition stands may only be fastened with adhesive tape, which must later be removed without a trace.

In general, all materials used must be removed without trace. Substances such as oil, grease, paint and similar must be removed from the floor immediately. Hall floors are not to be painted or glued.

Spielwarenmesse eG reserves the right to pass on the cost of repairing damage to the hall floor and removing soiling to the person responsible.

Carpets and other floor coverings in the exhibition areas have to be **flame retardant** to DIN 4102 B1 or EN 13501-1 **Class Cfl as a minimum**. A certificate verifying the building material class of the material used must be kept at the exhibition stand.

If **high-pile carpet** or floor coverings are made from **synthetic grass**, the fire and smoke behavior (according to EN 13501) in combination with the requirements for laying and installation must be taken into account since these floor coverings generally do not meet fire protection requirements. Due to their burning and dripping behaviour, floor coverings may not be installed on walls or above people. Further requirements regarding the necessary fire behavior are provided in 4.4.1.1. When using loose material or bulk solids (earth, sand, organic material etc.) the hall floor must be covered and protected from dirt and liquids. Dust development and distribution are to be counteracted using suitable means. During trade fair operations loose material must be prevented from getting onto the traffic areas.

Freely accessible **platforms, double floors or raised floors** with a maximum height of 0.20 m must be sufficiently load-bearing. A **vertical load capacity of at least 5.0 kN/m²** must be proven. These raised surfaces must be tightly jointed and enclosed on all sides. Further requirements for structures which can be walked on are given in Item 4.6.

Floor anchors and mountings are not permitted on the hall floors. NürnbergMesse is entitled to remove floor anchors installed by exhibitors or their authorized representatives at the exhibitor's cost and risk (flat repair cost charge: EUR 250 before tax, per floor anchor).

Anchors and fixing of stand structures in the hall floor are not allowed. The fixing of exhibits using **floor anchors** is only permitted in justified exceptional cases and with the written permission of Spielwarenmesse eG. Exhibitors do not have a right to install and use floor anchors. Applications must be submitted on time (see Item 4.2) with scale plans showing the location, type of anchor, loading at the anchor and drilled hole diameter plus the number of anchors. The exhibitor must provide written evidence that the exhibit is also stable during operation. Tensile forces at the anchor are not permitted. The number of anchors must be limited to the quantity absolutely necessary.

Spielwarenmesse eG reserves the right to lay down the materials to be used for anchors. If impermissible materials are used or if floor anchors are installed without the written approval of Spielwarenmesse eG, these will be removed at the exhibitor's expense (flat-rate repair cost of EUR 250 – net price per floor anchor) and risk by Spielwarenmesse eG. Any heavy-duty anchors, screws or anchor bolts must be removed by the exhibitor or its representative during dismantling; care should be taken to ensure that anchor bolts are twisted out and may not be cut off flush. If this requirement is not observed, the exhibitor shall be liable for consequential damage. Spielwarenmesse eG is entitled to remove any heavy-duty anchors, screws or bolts left in place at the exhibitor's expense and risk.

Stand structures that are not approved, or which do not comply with the Technical Guidelines or the current state of the art, must be modified or removed if required. If this is not done on time, Spielwarenmesse eG is entitled to carry out the changes itself at the exhibitor's expense or to prohibit the use of the exhibits.

Only the relevant ServicePartners of NürnbergMesse are permitted to use supply ducts and floor shafts.

4.7.5 Suspending objects from hall ceilings

It is possible to hang objects from the facilities provided for this purpose in accordance with the relevant regulations DGUV Regulation 17 and the

applicable exhibition technology standards (IGVV SQ P1 to SQ P5 with SQ Q1, SQ Q2 and SQ Q2) (see Instruction Sheet **i4.9 "Suspension points, trusses and lifting equipment"**). This also applies to pre-rig trusses, elevated truss systems (e.g. ground support), tripods and other constructions.

4.7.5.1 Provision of suspension points

The provision of suspension points and modification of suspension carried out exclusively by Spielwarenmesse eG through its appointed ServicePartners. The suspension point will be provided for the exhibitor in the desired position in the space above the stand if structural conditions permit. The number of possible suspension points in the halls depends on the stand size and the grid of the hall ceiling. **The provision of suspension points cannot be guaranteed in all areas.** This applies mainly to the peripheral areas of the following halls:

- **Halls 3A, 3C and 11.0:** No suspension points can be provided over the exhibition areas in the area of the loading yard gates with limited headroom. The necessary minimum distances from the sprinkler heads must also be strictly observed in these areas (see Point 3.1.4). Information on the reduced bearing load of suspension points in Halls 3A and 3C can be obtained from the responsible Service Partner.
- **Halls 4A, 7A:** Only a few suspension points with a reduced bearing load are available in the exhibition areas in the area of the loading yard gates with limited headroom. The application of dynamic loads and the use of lifting equipment here are permitted only after consultation with and approval by the responsible ServicePartner.

The prescribed (maximum) heights for construction and advertising must be observed.

Suspension points incl. installed equipment are to be mounted with a residual clearance of at least 2.50 m below them.

The ServicePartner of Spielwarenmesse eG check the feasibility of the desired suspension points using the documents submitted and reserve the right to have the suspension loads and the rig used inspected by a structural engineer. This inspection is subject to a fee, which is charged to the **exhibitor or person ordering** the suspension points.

The **maximum vertical structural load capacity of each suspension point is 25 kg (0.25 kN) for halls 1, 2, 3, 4, 5, 6, 7, 8, 9, 10 and 12 and the separation between suspension points in halls 1, 2, 3, 4, 5, 6, 7, 8, 9, 10 and 12 must not be less than 1.00 m. The maximum vertical structural load capacity of the available suspension points in halls 3A, 3C, 4A, 7A and 11 is 240 kg (2.4 kN).** Higher loads are only possible on request and require written approval by Spielwarenmesse eG.

If the ordered suspension point is not below an existing suspension point or under the beams of the hall roof structure, the suspension point will be provided by using a pre-rig. The end of each suspension point (transfer point) is to be notified beforehand to the responsible ServicePartner using the order form.

The use of "bridles" at suspension points in the hall is not permitted on the exhibition site.

In the case of complex systems (statically indeterminate systems, generally more than single-span girders) a load plan must be submitted showing the total load and the loads on the suspension points (supporting loads). Spielwarenmesse eG reserves the right to request the installation of load measurement systems for statically indeterminate systems. The load measurement systems may only be delivered, installed, and operated by the responsible ServicePartner of Spielwarenmesse eG. Load measurement systems are provided at extra cost, which will be charged to the exhibitor.

Please note that the use of load cells can reduce the maximum suspension height by up to 50 cm.

For technical or organizational reasons, suspension points above the exhibition stand may already have been prepared or installed for subsequent events. The exhibitor/stand builder must not be entitled to remove these suspension points and must not use or modify them.

4.7.5.2 Attaching objects to suspension points

The objects to be suspended (lighting bars, spotlights, projectors, loudspeakers, etc.) may only be mounted by the exhibitor's own **skilled staff**, approved **contractors or the ServicePartner** in accordance with legal standards in force and current engineering practice. When selecting the **skilled personnel** on site or the supervising person (coordinator), the provisions of the current guidelines as per DGUV regulation 17, the DGUV Information Sheet 215-310 and in accordance with IGVV SQ Q2 must be observed. **Evidence of the required qualifications** must be carried.

When installing lighting trunking systems the associated spotlights and accessories must also be provided with an adequately dimensioned secondary fuse in accordance with the latest engineering practice (DGUV Information Sheet 215-313).

Further information on approved and non-approved attachment gear, load-bearing lines, load-bearing equipment, fasteners, rope terminations and lifting equipment can be obtained from Instruction Sheet **i4.9 "Suspension points, trusses and lifting equipment"**.

The regulations listed below must also be observed for safety reasons.

The following are not (!!) prohibited:

- Suspension points used for securing stand components or exhibits (stand components or exhibits must stand securely on their own)
- Suspended constructions with a rigid or non-positive connection to the hall floor (structures with an additional connection to the roof supporting system as a result of suspension points)
- The use of bridle suspension points

4.7.5.3 Use of truss systems

The use of trusses, rigs and truss systems is governed by the requirements and implementation instructions of DGUV Regulation 17, DGUV Information Sheet 215-313 and the Quality Standard IGVV SQ P1. This is independent of the type of use of the trusses, rigs or truss systems, which can be hung, moving or ground-supported.

The use of trusses, rigs and truss systems outdoors is governed by the requirements for "temporary structures" (Code of Practice for the Construction and Operation of Temporary Structures, German FlBauR). In addition, the Quality Standard IGVV SQ P5 and DIN EN 13814 (Safety of Carnival Rise and Leisure Facilities).

For rigs that cannot support the load of a single-span girder (girder/truss on two supports or two suspension points), evidence of structural strength may be requested at the exhibitor's cost.

The data sheets must be enclosed for the trusses used. If temporary structures are used, the building permit (Baubuch) must be carried. Conductive parts must be included in the measures to protect against direct contact by providing additional equipotential bonding (see Item 5.3.3).

4.7.5.4 Use of lifting equipment

The use of lifting equipment (electric chain hoists, manual chain hoists, etc.) is only possible in halls 3A, 3C, 4A, 7A and 11 and requires prior approval by Spielwarenmesse eG.

The use of lifting equipment (electric chain hoists, manual chain hoists, etc.) in halls 1, 2, 3, 4, 5, 6, 7, 8, 9, 10 and 12 is strictly prohibited!

The use of lifting equipment is governed by the requirements and implementation instructions of DGUV Regulation 17, DGUV Information 215-313 and the industry standard SQ P2.

A suitable rope termination (e.g. ring or rope socket) must be provided. Wire rope fasteners (holders, sliders) are only designed for static loads and must not be used in conjunction with lifting gear. Cable holders must be used at least in pairs, i.e. the objects suspended in this way must be fixed to at least two wire ropes in order to stop the load twisting around its own axis on the wire rope. Cable holders may not be installed in the securing chain of the secondary safety component against falling.

Secondary safety devices must be provided for all lifting equipment and slings (polyester round slings) in accordance with the latest engineering practice. The use of lifting gear must be advised when ordering suspension points!

4.7.5.5 Electric chain hoists

Electric chain hoists may only be used in halls with heavy duty suspension devices (halls 3A, 3C, 4A, 7A and 11). The use of this lifting gear is subject to the Requirements for Electric Chain Hoists in Event Technology (IGVV SQ P2).

The dead weight of the electric chain hoists and dynamic coefficients must be taken account of in the load plan so as not to overload the slinging points and slinging material.

The contractor must subject the hoists to an annual inspection. The test certification mark must be affixed to a visible location on the lifting equipment and the test documentation has to be available on site at all times. This inspection does not replace the inspection by an officially appointed expert every four years.

4.7.5.6 Manual chain hoists

Manual chain hoists may only be used in conjunction with heavy duty suspension devices (halls 3A, 3C, 4A, 7A and 11).

Manual chain hoists may only be used in the case of statically determinate systems, i.e. a line load on two hoists or a distributed load on three hoists. The use of manual chain hoists for complex systems is not admissible. The carrying and load hook of the hoist must be in a perpendicular straight line above the centre of gravity of the load. Winding round the load with the chain (carrier) or guiding the load chain over corners is not admissible. Loads must always be moved with all attached manual chain hoists at the same time, i.e. there must be as many people lifting at the same time as there are manual chain hoists in use. It must be ensured that the lifting and lowering processes are uniform.

The dead weight of the manual chain hoists and dynamic coefficients must be taken account of in the load plan so as not to overload the slinging points.

4.7.6 Stand partition walls

The stand partition walls are fiber board or plastic-coated walls depending on the event. They are not suitable for mounting heavy objects and have no support function during assembly and dismantling. It may be necessary to erect additional supporting walls at extra cost, which may only be removed on the instructions of the organizer.

4.7.7 Advertising materials, presentations

The lettering on stands and exhibits, company logos and trademarks must not exceed the specified construction height and should create an attractive impression.

Presentations and slow-moving visual and acoustic advertising and musical reproductions are permitted, provided they do not annoy neighboring stands, do not cause congestion in the gangways and do not drown out the public address systems in the halls. The loudness at the edge of the stand must not exceed 70 dB(A). When mounting loudspeakers and sound systems they must be directed towards exhibitor's own stand area. Spielwarenmesse eG can intervene if these regulations are violated and may demand that the items causing the noise are shut down. In the case of show events the provisions of the German accident prevention regulation "Venues and production sites for stage presentations" (DGUV Regulation 17) must be observed.

Shows or product presentations with performance elements must be notified to Spielwarenmesse eG.

It must be demonstrated here that there is enough room for spectators on the stand surface. It must be ensured that the demonstrations/advertising measures do not cause any blockages, interference or congestion in the passageways. The demonstrations must not have any adverse impact on neighbouring stands and other exhibitors.

Spielwarenmesse eG is entitled to restrict or prohibit previously approved demonstrations if they create a danger for visitors or exhibitors. In addition, demonstrations may be restricted or prohibited also by reason of optical or acoustical impairments of the current exhibition/ event operation, the emission of substances (dirt, dust, steam, smoke, odours) or by reason of vibrations.

The distribution of printed matter and the use of advertising material are permitted only in the exhibitor's own stand space. Advertising structures inside the stand must not protrude into the gangways or be mounted higher than the prescribed height. Advertising that contravenes legal regulations or offends against moral standards is not permitted. Advertising packages or advertising material of companies not registered at the event must not be displayed.

Exhibits are not to be set up outside the stand limits. Possible advertising offers can be found in the Online Service Center (OSC) section

Marketing Services.

4.7.8 Accessibility

Stands should be designed to be accessible. Stands and their facilities should also be accessible for and usable without assistance by persons with mobility limitations.

We recommend installing suitable ramps with a maximum slope of 6 % and minimum width of 1.20 m and a non-slip floor covering.

Doors need to have a clear opening width of minimum 0.9 m.

Areas of movement and traffic areas need to be at least 1.5 m wide.

4.8 Outdoor area

The outdoor area of NürnbergMesse GmbH consists of paved or asphalted traffic areas and uneven, mostly non-compacted ballast lawn areas or grown lawn areas.

During event opening times, the outdoor area is illuminated by general road and path lighting after dark. The necessary service connections are available at irregular intervals.

The general provisions of the technical guidelines for stand construction also apply similarly for stands in the outdoor area. Other supple-

mentary instructions are provided in the Instruction Sheet **i4.14 "Stand structures in the outdoor area"**.

Responsible person

At the time of registration or at the latest upon commencement of assembly, a **technically responsible person must be named along with his or her mobile telephone number. This person must be continuously reachable at during all event phases** (assembly/event times/dismantling) and must be able to immediately initiate and perform the necessary measures to halt operations in response to weather alerts or disturbances.

4.8.1 Stand approval/stand structures requiring permission

Depending on the type and extent, stand structures and special constructions in the outdoor are subject to review and approval by the relevant authority. They are also fundamentally subject to written approval by Spielwarenmesse eG. To this end, (see Item 4.2) an audited or auditable structural analysis (proof of stand safety), dimensioned layout plans and views of the structures and designs must be submitted for review and approval in a timely manner. The type and extent of stand structures requiring permission and approval are defined in Instruction Sheet **i4.14 "Stand structures in the outdoor area"**. An audited or auditable proof of stand safety must be provided in every case.

Stand structures in the outdoor area of the Exhibition Centre that are subject to permission and approval include all structural installations that are to be classified as regular **temporary structures** according to **Art. 72 BayBO** with a valid model permit or are comparable to them in terms of their construction and design, and all other walkable and/or covered, space-creating or freestanding structural installations (e.g. tents, stages, show trucks, etc.). In erecting and operating non-stationary stages and stage coverings, the requirements of the Quality Standard **IGVV SQ P5** must also be met. A copy of the registration with the government authority must be submitted to Spielwarenmesse eG no later than 14 days before the beginning of the event.

If you have any questions, please contact

Bauaufsicht Süd

Bauhof 5

90402 Nürnberg

Tel. +49 911 231-4371.

The costs for the necessary acceptance of the temporary structure by the relevant authority will be billed to the exhibitor/stand builder.

4.8.2 Excavations and floor anchors

In general, excavations and ground anchors (e.g. ground stakes) are prohibited in the outdoor area.

If you do not follow this rule, you will be generally liable for all losses and consequences resulting from damage to pipes and cables (even if you are in possession of a separate approval and permission from Spielwarenmesse eG).

Materials placed in the outdoor area must be removed without a trace and the original condition restored.

4.8.3 Weather-related loads

4.8.3.1 Wind loads

As a general rule, all stand structures in the outdoor area must be rated for wind loads in accordance with Eurocode 1: **DIN EN 1991-1-4** with due regard to the local wind zone.

4.8.3.2 Wind loads for temporary structures

If a structure is a **temporary structure** under the building codes according to **Art. 72 BayBO**, the wind loads according to DIN EN 13814, 4.3.3.4 (for exhibition installations) and DIN EN 13782, 6.4.2.2 (for tents) in conjunction with the "BayBO List of technical rules introduced as technical building regulations" may be applied.

If an operational load case according to DIN EN 13814, 4.3.3.4 is claimed, the exhibitor/stand operator must take organizational measures to ensure the cessation of operations from a **wind speed of v10 = 15 m/s** (also in gusts).

4.8.3.3 Snow loads

No snow loads need to be considered for stand construction measures in the snow-free period (April - Oct.). For stand construction measures in the **winter time (Nov. - March)**, the regular snow loads according to Eurocode 1: **DIN EN 1991-1-3/NA** must be demonstrably considered for all supporting roofs, with due regard to the local **snow load zone**.

4.8.4 Weather alerts

The stand operator is obligated to pay attention to weather forecasts and take the necessary protective measures, up to and including

dismantling or cessation of operations, in response to weather alerts. In addition, the exhibition company will issue a general weather alert to the designated responsible person of the outdoor stand operator in accordance with Item 4.8.

In the case of mobile installations (e.g. small exhibits, furniture, sunshades, small promotional displays, etc.), the exhibitor/stand operator must ensure that they can always be quickly dismantled and adequately secured in response to weather alerts.

4.8.5 Exits/escape routes

The escape **route length** from every visitor site to the next exit to the outside may not be longer than **30 m**.

The width of escape routes must be measured on the basis of the highest possible number of persons. The clear width of every part of escape routes must be at least 1.20 m.

The clear width of escape routes must be dimensioned for the persons who rely on them:

- 1.20 m for each 200 persons in enclosed rooms
- 1.20 m for each 600 persons in outdoor areas.

Steps are only permitted at intervals of 0.60 m.

Enclosed rooms with a surface area of more than 100 m² must have at least two exits, if possible on opposite sides.

The clear width of the exits must be equal to the width of the escape route. The necessary exits must be permanently and well visibly marked with appropriate emergency exit pictograms. Additional requirements for the marking of escape and emergency routes can be found in 4.5.1.

4.8.6 Glass

Only safety glass suited for the intended purpose may be used.

Additional information on the use of glass and acrylic glass is provided in Item 4.4.3.

4.9 Multi-storey stands

4.9.1 Application

Multi-storey stands are only possible in the exhibition halls if authorized by Spielwarenmesse eG. The application must be submitted immediately after receipt of stand approval and at least until 30 November 2024.

The necessary application form is contained in the Online Service Center section Services & formalities -> **Multi-storey stand**. Multi-storey stands are not possible in halls 10.1, 11.1 and 12.2.

4.9.2 Regulations on building over stand areas, safety clearances, height of rooms in stands

The maximum height of structures is shown in the Instruction Sheet "Hall details at a glance". The clear height of inside rooms of multi-storey stands must be at least 2.30 m on the ground floor and upper floors. For fire safety reasons, a sprinkler system must be installed by the responsible ServicePartner BSS to protect the structure. By way of exception, smoke or differential heat detectors must be installed by the relevant ServicePartner SPIE SAG GmbH in halls 4A, 7A and 11 as an alternative to a sprinkler system. Stand structures bordering on neighbouring stands are to be finished in a light and neutral single colour above the height of 2.50 m.

4.9.3 Permissible loads/load assumptions

The **vertical loads** for the ceiling of a multi-storey stand inside an exhibition hall must comply with Eurocode 1: DIN EN 1991-1-1/NA:2010-12 Table 6.1DE [Cat. C] as follows:

- Load required for **restricted use** by visitors or stand staff for meetings and customer support, i.e. furnished with tables and chairs arranged at random or divided into office cubicles **$q_k = 3,0 \text{ kN/m}^2$** (Cat. C1).
- Load required for **unrestricted use** as freely accessible display and meeting area or as sales space with or without closely spaced seats **$q_k = 5,0 \text{ kN/m}^2$** (Cat. C3).

The respective option must be clearly identified in the plans submitted for approval.

- **Staircases and stair landings** must always be designed for a load (Cat. T2) of: **$q_k = 5,0 \text{ kN/m}^2$** .

To achieve sufficient **longitudinal and lateral stability** for multi-storey exhibition stands or platforms, a horizontal load of **$H = \sum q_k/20$** (q_k = vertical load) is required at the height of the floor of the second storey.

For **balustrades and railings**, a horizontal load of **$q_k = 1,0 \text{ kN/m}$** at handrail height (at least 1.10 m) must be applied according to Eurocode 1: DIN EN 1991-1-1/NA:2010-12 Table 6.12DE.

The fall-protecting function of **outer walls** in the upper floors must be appropriately demonstrated. **A horizontal equivalent distributed**

load $q_h = 0,125 \text{ kN/m}^2$ (see Item 4.1) must be taken into consideration in order to achieve adequate protection against tilting and sliding and ensure the stability of stand structures.

It must be verified that the permissible loads on the hall floor are not exceeded, e.g. by single supports (see Item 3.1 Hall details). If required, load-distributing floor panels have to be provided underneath the supports. Service ducts and covers must be covered with floor panels to prevent loads on them. The proof of stand stability must take into account that floor anchors are not admissible.

4.9.4 Escape routes, stairs

The **walking distance** to the next hall necessary gangway from any accessible point on the top floor of a multi-storey stand **must not exceed 20 m**. Escape routes may not pass through functional areas (e.g. kitchen, storage room). The following minimum **number and clear width of escape routes** (exits, corridors) are to be provided:

- up to 100 m² and less than 100 people: 1 escape route (minimum clear width 0.90 m)
- over 100 m² and less than 200 people: at least 2 escape routes (minimum clear width 0.90 m)
- more than 100 m² and more than 200 more than: at least 2 escape routes (minimum clear width 1.20 m each)

Escape route widths are to be graduated only in 0.60 m increments per 100 people.

If the floor space of the upper floor exceeds 100 m², at least two stairs are required. The stairs must be positioned opposite each other. All **stairs** must conform to DIN 18065 and must have a clear width of at least 1.20 m. The necessary stairs and the stairs used for general visitor traffic must have closed steps. Winding or spiral stairs are not permitted. The rise of the stairs must not exceed 0.19 m and the depth of the treads must not be less than 0.26 m. When determining the tread width, it should be ensured that "undercutting" (e.g. with risers) cannot be taken into account. Furthermore, in designing the undercutting, care must be taken to ensure that the heel is not caught when going down stairs. With stairs, an intermediate landing must be provided after 18 steps. The depth of the landing should be a multiple of the step dimension. An uneven number of steps should be taken as a basis.

Stairs may not begin immediately behind a door. There must be a sufficient landing (min. depth 1.0 m) between the staircase and the door. Hand rails must offer a firm grip and be continuous. The side clearance between hand rails and adjacent parts must be at least 0.05 m. Stairs must have handrails on both sides. Stairs more than 2.40 m wide must have central handrails. The clear headroom must be at least 2.00 m. Due to the design of multi-storey exhibition stands, the general **safety lighting** available in the hall may not work in all areas of the stand in the event of a power outage.

To ensure that persons in these enclosed areas can find their way safely to the general traffic areas, it is necessary to install an additional, own safety lighting system (see Item 5.3.5), which must be coordinated with Spielwarenmesse eG in advance (see Item 4.2).

Escape and emergency routes must be permanently marked in accordance with ASR A1.3 or DIN EN ISO 7010, DIN EN 1838 and DIN 4844-1. It must always be possible to open the doors to these exits from inside to the escape direction during the event and these doors must not protrude into the hall gangways. An appropriate niche must be provided in any case.

4.9.5 Building materials

In the case of multi-storey stands the load-bearing structures, ceilings on the ground floor and floor of top floor have to be made of flame resistant materials (to DIN 4102 or EN 13501-1) or flame retardant components as a minimum. Further requirements relating to stand construction and decoration material are described in 4.4.1.1. Stand roofing/ceilings are to be executed in accordance with 4.4.2.

4.9.6 Upper floor

If balustrades are necessary on the upper floor, a lip of at least 5 cm must be provided on the floor at the base of the railings to **prevent objects rolling over** the edge. **Railings and balustrades** are to conform to **Item 4.6** and **Item 4.9.3**. Handrails/upper balustrade ends must be designed in such a way as to prevent the placement of objects and the risk of their falling below. The fall-protecting function of **outer walls on the upper floor** must be assured and demonstrated in the structural calculations. If **ceilings above the upper floor** are closed design, the requirements for **stand roofing** as per **Item 4.4.2** must be observed.

All reception and lecture rooms enclosed on all sides must have a **line of sight** to the hall. For other requirements please refer to Item 4.4.4. In addition to the fire extinguishers available on the ground floor, on the upper floor at least one **fire extinguisher** (EN3) must be provided ready for use in a prominent position for each stairway (see Item 4.4.1.13).

4.10 Contraventions/violations and liability

Stand structure that have not been approved and do not fulfil the Technical Regulations or applicable laws may have to be modified or removed by the exhibitor or stand builder. If the work is not performed in a timely manner, Spielwarenmesse eG will be entitled to make modifications itself and/or arrange to have modifications made by third parties at the cost and risk of the exhibitor. The partial or complete closure of the stand may also be ordered for an important reason, particularly including safety defects. Within the scope of its obligation to ensure traffic safety, Spielwarenmesse eG will be entitled at all times to implement necessary safety measures and charge the resulting costs to the causer or exhibitor. If the exhibitor or the stand builder engaged by the exhibitor does not observe the foregoing stand construction regulations, the exhibitor will be liable for all damage resulting from the violation of stand construction regulations. Furthermore, the exhibitor or the stand builder engaged by the exhibitor will be obligated to indemnify Spielwarenmesse eG from all claims of third parties asserted as a result of the violation of the foregoing stand construction regulations. Any and all claims for damages asserted against Spielwarenmesse eG or its successor enterprises as a result of the loss, damage or impairment of the submitted drafts, models or other documents shall be excluded regardless of the legal grounds in cases of negligent actions or omissions.

■ 5. Industrial safety, technical safety regulations, technical rules, technical supplies

5.1 General regulations

Assembly and dismantling work may only be carried out in accordance with labour and industrial regulations. The exhibitor/stand builder/customer is responsible for operating safety and for compliance with the Occupational Health & Safety and Accident Prevention Regulations on his stand/event area.

5.1.1 Damage

Any damage to the exhibition grounds, its buildings or installations caused by exhibitors or their agents will be rectified by Spielwarenmesse eG at exhibitor's cost after the end of the event

The exhibition areas must be restored to their original condition after dismantling and all damage is to be notified to the event organizer.

The exhibitor is responsible for any damage caused to the hall ceilings, walls, floors and installations. Stands not dismantled or exhibits not removed by the official deadline for **dismantling** may be removed and stored by the exhibition forwarding agent at the exhibitor's cost and risk or disposed of at the exhibitor's cost.

5.1.2 Coordination of work at the exhibition stand or event grounds

If the employees of different companies must perform work concurrently at the exhibition site/stand area (especially in the assembly and dismantling phases), the **stand construction supervisor/assembly supervisor** must perform a **coordination according to the German Working Conditions Act** (ArbSchG) and DGUV (German Statutory Accident Insurance) Regulation 1 to rule out possible mutual threats. This applies particularly also to the work performed by service providers of the exhibition company on the exhibition stand.

In addition, necessary measures to improve the safety and health protection of employees in the workplace in accordance with the currently valid European Directive EC-RL 89/391/EWG must be observed and implemented in the work performed at the exhibition site.

Entering the exhibition site during assembly, conversion, and dismantling may be associated with dangers that necessitate the wearing of suitable **personal protective equipment (PPE)**. The exhibitor must conduct a risk assessment for its employees and contractors under its own responsibility and inform them of dangers, compensation measures, and suitable personal protective equipment (PPE). The exhibitor is responsible for implementing and monitoring the specified measures.

5.2 Use of tools and equipment

The use of bolt-firing tools, nail guns and chain saws is prohibited. The use of woodworking machines without sawdust extractors is prohibited. In general, all types of **wood working** during the event must be notified to Spielwarenmesse eG (see Item 4.2) and require a written approval. During all wood working demonstrations, suitable safety enclosures

must be provided for the protection of visitors (see also Item 5.6.2.1). Furthermore, suitable fire prevention measures must be implemented. The requirements of DGUV Information 203-006 must be observed in the selection and operation of **electrical equipment and tools**. Rented elevating work platforms may only be operated by qualified persons above the age of 18 years. Proof of qualification to IPAF or DGUV Rules of Procedure 308-008 must be provided. Drivers must be in possession of driving licences at all times.

Cranes and forklift trucks may only be used by the forwarding agents appointed by Spielwarenmesse eG.

For safety and liability reasons, working platforms etc. may only be requested via our ServicePartner SPIE SAG GmbH. Item 4.4.1.11 must be observed with respect to abrasive cutting work and all other work involving an open flame.

5.2.1 Explosive mixtures

Explosive mixtures may be formed when handling flammable hazardous materials (e.g. liquids, gases, dusts. etc.).

It is therefore essential that an **explosion protection document** is prepared for all systems, structures, exhibits or demonstrations involving hazardous materials of this type. The explosion protection document must be drawn up by the exhibitor. The complete explosion protection document must be submitted by the exhibitor to NürnbergMesse in time (see Item 4.2) beforehand for approval. Safety against explosion will be tested on site, for a fee, before the system is taken into operation (before the start of the trade fair).

If no explosion protection document is submitted or if defects are found during the inspection on site, the operation of the system/the demonstration cannot be approved.

Detailed information about the explosion protection document and the explosion safety test is provided in the Information Sheet **i4.15 "Explosive Mixtures"**.

5.2.2 Devices for catching wood dust and shavings

Devices for the extraction and storage of dust, shavings or chippings from wood or wood materials (e.g. silos) must be tested before start of operation in accordance with the German Hazardous Substances Act (GefStoffV) by a person authorized to carry out testing according to the German Occupational Health and Safety Regulations (BetrSichV), taking into account the proposed mode of operation, to ensure that they are in order in terms of their assembly, installation, set-up conditions and safe function.

In general, devices of this type must be notified in time (see Item 4.2) in advance to Spielwarenmesse eG for approval. The operator of the system is responsible for guaranteeing operating safety on start of operation (see Item 5). The operator/exhibitor must draw up a **risk assessment in the form of an explosion protection document** (according to the Hazardous Substances Regulations, Industrial Safety Regulations, TRGS 720 bis 725 und TRGS 727) and enclose it with the notification (see Information Sheet **i4.15 "Explosive Mixtures"**).

If **wood working machines** are demonstrated during the trade fair so that an increased **amount of dust or shavings** becomes likely, the provisions of DGUV Information 209-083 and 209-045 regarding the installation of automatic spark extinguisher systems must be also be followed. In justified exceptional cases (e.g. restricted demonstration of the system), there may be no need to install the spark extinguisher system once approval has been given in writing by Spielwarenmesse eG (see Item 4.2).

5.3 Electrical installation

5.3.1 Connections

When ordered, each stand to be supplied with electricity will receive one or more connections which will be installed exclusively by the relevant ServicePartner of Spielwarenmesse eG. The installation of these connections is only to be carried out by the responsible ServicePartner of Spielwarenmesse eG. The layout plan showing the desired position of the connections is to be enclosed with the orders on the order form. Electricity consumption will be charged at a fixed amount for connections up to 20 kW and based on meter readings for connections over 20 kW.

The power supply is available from the start of assembly until the end of dismantling. Other times of availability can be arranged with the responsible ServicePartner. The exhibitor is obliged to protect his supply connection point against damage and accidents.

For safety and fire protection reasons, all electricity consumers must be shut off upon leaving the stand at the end of every event day. By way of exception, safety systems, emergency lighting, refrigerators and servers may remain in operation. Generators may not be used at exhibition stands.

5.3.2 Stand installation

Electrical installation work on the stand can be carried out to order by the responsible ServicePartner of Spielwarenmesse eG. Within the stands, i.e. from the transfer point, installation work after the supply connection point on the stand can be carried out by the exhibitor's own electricians or by approved electrical contractors in accordance with VDE regulations, applicable European regulations and current engineering practice. If clamp or screw connections are used in the installation within the stand, the electrician performing the work must inspect the installed system. Afterwards, the electrician must prepare written documentation of the inspection (measurement reports and construction certificates), which must be kept on hand at the stand for examination. In addition, the valid inspection reports for all electrical equipment according to DGVU Regulation 3 must be kept on hand. Connections, machines and equipment that do not comply with the regulations or whose consumption is higher than registered are inadmissible. Such items may be removed from the stand and taken into custody by Spielwarenmesse eG at exhibitor's cost and risk.

5.3.3 Installation and operating regulations

The entire electrical installation is to be carried out in accordance with the latest safety regulations of the Electrical Engineering Association (VDE) and Accident Prevention Regulations (DGVU Regulation 3). The requirements of VDE 0100, VDE 0100-706, VDE 0100-718, VDE 0108, VDE 0128, VDE 0100-560 and VDE 0100-711 (IEC Standard 60364-7-711) must be observed in particular.

The exhibitor assumes full liability for damage resulting that may occur due to faulty electrical installations on halls and building parts of the exhibition site and on the stands and exhibits of other exhibitors.

Protection with residual current devices (RCD) is mandatory for all power circuits.

An RCD with a maximum fault release current of 30 mA is specified for mains sockets and lighting circuits. Another suitable method of protection may be used for special machinery and equipment (frequency converters). The exhibitor is responsible for such measures.

The amount of high- or low-frequency interference with the mains supply must not exceed the limits stated in VDE 0160 and VDE 0838 (EN 50 006 and EN 61000-2-4).

Cables with solid conductors must be laid and connected permanently. Flexible cables must be provided with strain relief devices. The minimum specification for all cables used during assembly and dismantling is H07RNF or at least equivalent (VDE 0298). Cables such as H05... or similar may only be used in areas where they are subject to low mechanical loads (VDE 0298). Only cable with a minimum cross-section of 1.5 mm² Cu may be used. Conductive components are to be incorporated in the precautions for protection against indirect contact (stand grounding and/or equipotential bonding).

Secondary circuits (all cables from the provided electrical connection) must be protected from short-circuit and overload using suitable circuit breakers.

Low-voltage systems may only be operated with safety transformers to DIN EN 61558 (VDE 0570) or 61046/61047 or equivalent. The transformers must be suitable for installation on combustible surfaces and their primary and secondary circuits equipped with protection against overheating, short-circuit and overload.

Bare (uninsulated) electrical conductors are prohibited in low-voltage lighting systems and cable systems must also be completely insulated. All terminal connections have to end in a closed box. Flexible cables (and flat cables) must not be laid under floor coverings without protection against mechanical loads.

The electrical installation on the stand may not be taken into operation for the event until it has been accepted and inspected and approved by an authorized person. An acceptance report must be available for inspection on the stand.

5.3.4 Safety measures

As a special precaution, all heat-generating electric appliances (hot plates, spotlights, transformers, coffee percolators, etc.) are to be mounted on non-combustible, heat-resistant, asbestos-free bases. Depending on the **heat generated**, sufficient separation is to be maintained from combustible materials.

Light fittings may only be mounted on non-combustible decorations or the like. Spotlights, floodlights, spotlights on luminaire tracks and their supply fittings such as power rails, switch boxes or similar are to be secured individually with **safety back-up wire ropes** to current standards. Power rails have to be fitted with protective caps. They must not

be fastened using cable ties. In the case of halogen lighting only spotlights with **protective screens** are admissible. In addition, suitable **shatter protection** as specified by manufacturer must be used in the case of lens spotlights (e.g. natural light spotlights with exchangeable lenses, or PAR spotlights with halogen bulbs).

When UV lamps are used, any threats resulting from increased radiation exposure must be ruled out. When discharge lamps are used, appropriate **UV filters** conforming to the manufacturer's instructions must be used. UV lamps of types UV-B and UV-C may be used for the intended purpose in devices designed for that purpose only if it can be assured that no unprotected radiation can escape.

Unauthorized modifications to hall lighting such as removing individual fluorescent lamps is prohibited.

5.3.5 Emergency lighting

Stands whose special design means that the existing general emergency lighting of the building is ineffective must have their own additional emergency lighting in accordance with DIN EN 50172 (VDE 108/100). This is to be designed to ensure safe access to the general escape routes.

5.4 Water and waste water installation

When ordered, each stand to be supplied with water and waste water drainage receives one or more connections to current standards. These connections may only be installed by the relevant ServicePartner of Spielwarenmesse eG. A layout plan showing the desired placement of the connections must be enclosed with the orders placed using the required form.

All installations inside the stands have to comply with the current regulations and engineering practice (e.g. drinking water regulations and DIN 1988), so as to prevent any lasting impairment of drinking water quality due to the installation and operation of a connection. Spielwarenmesse eG reserves the right to perform random inspections of the installations.

Continuous flow coolers may not be connected directly to the drinking water supply. It is forbidden to take water from hydrants or other fire extinguishing equipment.

For safety reasons, the water supply is shut off on the last day of the exhibition – usually one hour after closing time! Chemically contaminated waste water, food and grease residues must not be introduced into the waste water system but must be properly disposed of.

For more information, guidelines and conditions see the Online Service Center under Stands, technical equipment & services -> Technical services & logistics -> **Water supply & drainage**.

5.4.1 Connections

In the installation of the water connection, the feed line is usually installed in the form of a 1/2-inch hose and the drain line in the form of a 50 mm pipe (DN 50).

The connections lead from the service shafts in the hall floor within the stand area (positioned according to the hall layout plan).

Within the stand, the lines are laid on the hall floor, meaning that the arrangement of the pipelines must be coordinated with the relevant ServicePartner in advance and it may be necessary to consider the installation height of the pipes and lines.

The placement of lines that cross hall gangways or other stands must be avoided; in exceptional cases, such placement requires the prior written approval of Spielwarenmesse eG (see Item 4.2). The lines must be laid and covered in such a way as to ensure traffic safety. The exhibitor bears the costs of this work. Water pipes may not be placed in the hall gangways!

5.4.2 Use of water-bearing systems and equipment

When using water e.g. in basins, fountains, water walls, humidity or other water spray systems at the stand, the water must be completely hygienic. This is why when using such systems the circulating water must always be protected from infection. Documentary evidence of this must be produced at the request of Spielwarenmesse eG. The use of the systems described above must be limited on the stand area. Hall gangways or other exhibitors must not be located in the effective area of such systems or equipment. The exhibitor is liable for water damage and related consequential damage.

5.5 Compressed air/gas installation

5.5.1 Compressed air

When ordered, each stand to be supplied with compressed air (max. 7.5 bar) will receive one or more connections of the required size. The supply connection point is always fitted with a ball valve or quick coupler.

The installation of these connections is only to be carried out by the responsible ServicePartner of Spielwarenmesse eG.

The layout plan showing the desired connection points is to be enclosed with the orders on the order form.

The amount of compressed air used is included in the connection charge.

Compressed air is available during the official assembly and dismantling period. During the event, compressed air is available from 8:00 until closing time. For safety reasons, the compressed air supply is shut off at all other times. Compressed air can be provided outside the stated times by arrangement and at extra cost.

5.5.1.1 Connections

Nominal widths of up to 1 inch are possible for the installation of compressed air connections. The connections lead from the supply ducts in the hall floor within the stand area (positioned according to the hall layout plan). Within the stand, the lines are laid on the hall floor, meaning that the arrangement of the pipelines must be coordinated with the relevant ServicePartner in advance and it may be necessary to consider the installation height of the pipes and lines.

5.5.1.2 Stand installations

Qualified employees of the exhibitor may perform the installation of compressed air lines from the main connection and connections to exhibits inside stands if they observe the applicable regulations.

Alternatively, the work can be ordered from the responsible ServicePartner of Spielwarenmesse eG or carried out by suitably qualified outside contractors. The exhibitor bears responsibility for self-installation.

5.5.1.3 Installation and operating regulations

We recommend the installation of fine filters, water traps, reducing valves and safety valves to protect exhibits. The hoses and fittings used must be rated for a minimum operating pressure of 10 bar and protected against mechanical loads. The hoses must be laid and fixed to allow the smallest possible freedom of movement in the event of an accident – especially at the joints.

5.5.1.4 Compressed air cylinders

The large capacity of the supply network means that compressed air chambers/cylinders are not normally required for the operation of exhibits. In general, compressed air containers must be rated for a minimum operating pressure of 10 bar and equipped with tested and approved fittings according to the German Occupational Health and Safety Regulations (BetrSichV).

The inspection log for the specified initial inspection and regular 5- or 10-year inspections must be available on the stand.

Compressed air containers must pass an acceptance inspection by an authorized person (according to TRBS 1203 Part 2) before being taken into operation and the inspection certificate must be available on the stand.

5.5.1.5 Compressors

Own compressors are not permitted for operational safety reasons. This also includes the use of small or auxiliary compressors.

Compressors may be used under certain conditions and with the written approval of Spielwarenmesse eG (see Item 4.2).

Exceptions to the aforementioned prohibition are possible in the following cases:

- The compressor is an integral part of the exhibit
- The compressor is your exhibit
- The compressor is an integral part of the exhibit and is sold together with it

In general, compressors may only be used if they have been inspected by a capable person to verify their operability and operational safety in accordance with the applicable BetrSichV and TRBS 1203 (Part 2).

The noise produced by the compressor may not disturb exhibitors and visitors and may not exceed 70 dB (A) at the edge of the stand.

The manufacturer's EC declaration of conformity for the compressor is to be available at the stand.

The exhibitor is responsible for proper disposal of condensates and solids containing oil and waste oil. Evidence of this is to be available at the stand.

5.5.2 Gas

It is not possible to supply gas/natural gas from the hall network of NürnbergMesse.

Please refer to Item 5.7 if technical gases are used.

5.6 Machines, pressure vessels, exhaust gas systems

5.6.1 Noise emission

The operation of machinery and equipment causing noise is to be limited as far as possible in the interest of all exhibitors and visitors.

The noise at the edge of the stand must not exceed 70 dB(A) and measures to prevent the risk of hearing loss of the audience according to DIN 15905 (Part 5) must be taken. The exhibition management team may establish demonstration times for noise-generating machines and devices to prevent a continuous

noise nuisance for other exhibitors and visitors. Furthermore, if demonstrations cause noise, the exhibitor may be required to provide suitable hearing protection free of charge. The exhibitor must provide signs to draw attention clearly to the emission of noise and the provision of hearing protection. The operation of machinery and equipment with centrifugal force is only admissible provided there is no transfer to building components.

DIN 4150-2 can be applied to determine and comply with the permissible vibrational immission limits according to the Federal Immission Control Act (BImSchG).

5.6.2 Product safety

All exhibited products, equipment in need of monitoring, technical equipment, medical products and consumer products must fulfill the requirements of the Product Safety Act (ProdSG) and the respective harmonized EU regulations.

Technical equipment and consumer products not conforming to these requirements must bear a sign in a prominent position stating that they do not conform to the requirements of the above-mentioned act and cannot be purchased until they comply with the statutory requirements. The relevant manufacturer's declaration of conformity in the German language must be available on the stand for technical equipment and consumer products bearing the CE marking.

For demonstrations, the necessary protective precautions must be taken by stand staff. Your attention is also drawn to the Product Liability Act (ProdHaftG) and Product Safety Regulations (ProdSV).

5.6.2.1 Safety devices

Machines and apparatus may only be taken into operation with all safety devices in place. The normal safety devices may be replaced with a safety cover of safety glass or a similar transparent material if the same level of safety is assured.

If equipment is not being operated and is reliably secured against start-up, the safety devices can be removed to show visitors the design and finish of the covered parts. In this case, the safety devices must remain in a clearly visible position next to the machine. Risks of injury must be precluded under all circumstances.

5.6.2.2 Inspection procedures

The technical equipment on display will be inspected for accident prevention and safety by the responsible supervisory authority for each exhibition, if necessary with the responsible trade association committees, and checked for compliance with the safety requirements.

The EC declaration of conformity or manufacturer's declaration and operating instructions in the German language must be available for inspection on the stand to enable the authority to check the CE marking. In case of doubt, the exhibitor should contact the responsible authority at an early stage before the start of the exhibition.

5.6.2.3 Requirements for start of operation

Spielwarenmesse eG is entitled to ban the operation of machinery, apparatus and equipment at any time, if such operation is deemed to constitute a hazard to persons and property or adversely affect other exhibitors or the orderly running of the exhibition.

5.6.2.4 Supplemental protective measures

All work equipment or construction machinery must be currently tested in accordance with the Industrial Health and Safety Regulation (BetrSichV) and no unsecured loads may be hoisted over persons. Additional information on **loads over persons** at events can be found in the DGUV Information 215-313 "Loads Over Persons". Furthermore, it must be ensured by means of technical or organizational measures that the failure of a hydraulic system or cable drive cannot result in an **uncontrolled lowering of equipment parts or loads**. This can be assured, for instance, by blocking off the hazard area or by using hose breakage protection or a mechanical lock to support the hydraulic cylinder. The exhibitor is responsible and bears the burden of proof for stand safety and the safe operation of all exhibits.

Spielwarenmesse eG reserves the right to arrange for an on-site inspection to be performed by a qualified person at the expense of the exhibitor in justified cases.

As a general rule, all exhibits and equipment are to be placed in such a way that no extensions, booms or other movable components can

protrude from or swing out of the stand area. This applies also to the air space above the hall gangways and adjacent stands.

Equipment may only be operated by trained personnel of the exhibitor. The requirements of DGUV Rule 100-500 "Operation of Equipment" must be observed. If the exhibited equipment is equipped with an internal combustion motor or alternative drive system (e.g. electric or hybrid drive, gas-powered engine, fuel cell), the requirements set out in Item 4.4.1.2 must be observed.

The maximum permissible floor load in the hall must be observed in the placement of equipment and tools. Supply shafts and shaft covers must be spanned by suitable floor plates to prevent the occurrence of any stresses there. The exhibitor is responsible and bears the burden of proof for stand safety and the safe operation of all exhibits.

5.6.3 Pressure vessels

5.6.3.1 Acceptance certificate

Pressure vessels may only be operated on the stand if the inspections stipulated in the currently valid Occupational Health and Safety Regulations (German BetrSichV) have been carried out.

The associated inspection certificates are to be available at the installed location of the pressure vessel (exhibition space) and presented to the responsible supervisory authority or Spielwarenmesse eG on request.

5.6.3.2 Testing

In addition to the submission of certification on structural and hydrostatic pressure testing (EC declaration of conformity plus the necessary documents in German or English), an acceptance inspection must be conducted on site by a capable person or approved inspection agency. Pressure vessels and pressure systems must be inspected on site before initial operation, following modifications requiring a renewed inspection and then recurrently by the above-mentioned persons. If the pressure system is assembled on site at the exhibition centre, this system must then be inspected in the same way as before initial operation.

5.6.3.3 Rented equipment

As during the relatively short assembly period it is not possible to conduct assessments of pressure vessels without an EC declaration of conformity, preference should be given to rental equipment that has already been tested.

5.6.3.4 Supervision

The necessary acceptance certificate must be available for the trade inspectorate during the event at the exhibition stand. Information for specific exhibitions is available from the responsible supervisory authority.

5.6.4 Exhaust gases and vapors

Combustible and/or oily vapours, gases, aerosols and dust emitted by exhibits and equipment that constitute a health hazard or nuisance to the general public must not be discharged into the halls. They must be discharged outside through suitable pipes in accordance with the German Federal Immission Control Act.

Vapors or odors given off by cooking appliances must not be discharged into the hall but have to be removed using an exhaust air system or treated using suitable activated carbon or aerosol separators.

5.6.5 Exhaust gas systems

To discharge vapors and gases that are combustible, hazardous to health or a nuisance to the general public an exhaust gas duct with outlet has to be installed. The exhaust gas ducts will be mounted into the atmosphere only by the relevant ServicePartners of Spielwarenmesse eG using their own material, insofar as technically feasible. The connections to the exhibits are to be executed by the exhibitor. The connections must comply with the regulations in force and accepted engineering practice. Pipes discharging fumes and waste gas must be made of non-combustible materials. The distance from exhaust gas piping to combustible materials or similar must be at least 0.5 m and if necessary enclosed in a protective pipe or sleeve. Exhaust gas systems are generally to be approved in writing by Spielwarenmesse eG.

5.7 Use of compressed gases, liquid gases and combustible liquids, fuel paste and other fuels

5.7.1 Compressed and liquid gas systems

The storage and use of compressed and liquid gas in the exhibition halls or outdoor area is prohibited unless approved in writing by Spielwarenmesse eG.

5.7.1.1 Approval of compressed gas cylinders

The storage and use of liquid gas or other combustible or non-combustible

gases in compressed gas cylinders, compressed gas packs or tanks without the written approval of Spielwarenmesse eG (see Item 4.2) are prohibited. Compressed gas cylinders must be protected against impact, falling over, unauthorized use and heating up in accordance with the relevant accident prevention regulations.

When using technical gases, the supply in the stand must be limited to the lowest possible quantity that is immediately required for the work process. If necessary, the container must also be replaced several times a day.

The gas cylinder may be stored in the exhibition stand for day-today use only during the event hours. Technical gases (and compressed gas cylinders) must generally be stored outside of the halls during assembly and dismantling and overnight. Gas cylinders must feature approved safety valves and be sealed at the close of day.

Only one cylinder filled with combustible technical gases to a max. net weight of 5 kg may be used for each stand in the halls.

Non-combustible technical gases are limited to a max. net weight of 11 kg. Only one connected use cylinder may be located in the stand.

If a larger quantity of technical gas is needed to operate an exhibit, Spielwarenmesse eG shall work with the exhibitor, the relevant authorities and the ServicePartners to find a way of storing it outside the hall.

In addition to the currently valid Hazardous Substances Regulation (GefStoffV), the accident prevention regulations, the Sixth Regulation of the Product Safety Act (6th ProdSV), and the Technical Regulations TRGS 407, TRGS 510, TRGS 800, TRBS 3145, TRGS 745, TRBS 3146 and TRGS 746 must also be observed. Colour marking of compressed gas cylinders as per DIN EN 1089 is necessary.

5.7.1.2 Use of liquid gas

When using combustible liquid gas in the halls, only one compressed gas cylinder with a content of up to 5 kg may be set up in any one exhibition stand, subject to the written approval of Spielwarenmesse eG.

The lines to the operating unit and the feed line must be installed in the form of rigid pipes or flexible metal-reinforced hoses.

The operating unit must be set up on a large and non-combustible base at an adequate distance from heat sources and in such a way that it cannot topple over.

Open fireplaces and hot surfaces must be kept at a minimum distance of 1.5 m from emergency routes (e.g. hall gangways) and effectively shielded. A gas detection system is required in certain cases.

An acceptance certificate for the liquid cylinder must be prepared by a capable person and submitted to Spielwarenmesse eG. The prescribed instruction sheet for the operation of the unit must be displayed in a clearly visible place.

5.7.1.3 Installation and maintenance

Liquid gas systems are to be installed and maintained in accordance with the "Technical Rules for Liquid Gas" DVFG-TRF 2021 (publisher: DVGW Deutscher Verein des Gas- und Wasserfaches e.V. and DVFG Deutscher Verband Flüssiggase e.V.), DGUV Regulation 79 and the DGUV Regulation 80 "Use of Liquid Gas".

Please pay attention to Item 5.7.1.1. The operator of the system must prepare an **explosion protection document** in accordance with § 3 and § 5 of the German Occupational Health and Safety Regulations and submit it with the application for approval. The overall system must be **inspected by an expert (capable person)** in accordance with DGUV Principle 310-005 before being placed in service. The expert must be engaged directly by the exhibitor.

5.7.2 Combustible liquids

The storage and safekeeping of combustible liquids is prohibited as a general rule. Exceptions for operational reasons must be coordinated with Spielwarenmesse eG using the appropriate form at an early time (see Item 4.2); written approval is required.

DGUV Rule 113-001, TRGS 510 and the corresponding documents, as well as the instructions of the safety data sheet, must be followed. Because combustible liquids are usually also declared to be hazardous substances, the requirements of Item 5.8 must be observed. Combustible liquids kept on the site may not exceed the necessary quantity for the work process. The quantity kept on hand may not exceed one day's supply. Refillings must be notified and may only be done outside of visitor hours and in compliance with the technical safety regulations.

Emptied containers must be removed immediately from the hall.

The storage and safekeeping of flammable and/or explosive cleaning agents in the hall is prohibited.

The smoking ban must be strictly enforced (see also 4.4.1.8). Suitable extinguishing agents for liquid fires must be provided in a sufficient quantity. See Item 4.4.1.13.

The use of dummies is prescribed for exhibition purposes.

5.7.3 Open flame, fuel paste and other fuels

Heating and cooking appliances using wood, charcoal, gas or combustible liquids are not allowed in the halls. Chafing dishes used to keep food warm and operated with fuel paste may only be used with the approval of the Event Technology Department (see Item 4.2).

5.8 Hazardous substances

The deployment and use of materials or products containing asbestos, or of other hazardous substances or building materials containing hazardous substances, are prohibited.

This ruling is based on the Protection against Hazardous Substances Act (Chemicals Act), as amended, Federal Law Gazette (German BGBl) 1, Part 1, page 1703, in conjunction with the Prohibited Chemicals Act (Chem. Verbots V) and the Hazardous Substances Regulations (GefStoff V). In general, the use of substances declared or marked as a hazardous substance must be notified in good time to Spielwarenmesse (see Item 4.2). For inspection and release, it is essential that the notification is accompanied by a list of substances including the corresponding **safety data sheets and operating instructions along with a risk assessment**.

If hazardous materials are handled and used in connection with exhibits, the exhibitor must guarantee that this does not cause any risk. Based on the Hazardous Substances Regulations (Gef-StoffV), it is essential that the exhibitor prepares a risk assessment beforehand. The determined and specified protective measures must be implemented at the stand and the local staff must be instructed according to the risk assessment. The risk assessment and the safety data sheets for the hazardous materials must be kept permanently on the stand and displayed so that they are clearly visible.

5.9 Performance areas

Performance areas are defined areas used for artistic and other performances.

For performance areas of more than 50 m² or 200 m², "event equipment directors" must be appointed in accordance with § 39 of the Bavarian Venue Regulations (BayVStättV) in conjunction with § 40.

Even for smaller performance areas, complex technical installations and structures may require the presence of a "responsible person for event technology" according to BayVStättV § 39 in conjunction with BayVStättV § 40. The "responsible person for event technology", who will be present during assembly and dismantling, rehearsals and during the performances on location must be designated in writing to Spielwarenmesse eG (see Item 4.2 for contacts).

All stage and performance-related structures are to be installed as per the latest state-of-the-art (DGUV Regulation 17, formerly BGV C 1 and instructions contained therein). Spielwarenmesse eG must be notified of stage effects (e.g. wind, fog, pyrotechnics, activities involving fire hazards, candles etc.) at least 28 days before the event.

Please take note of Item 4.2.1, because certain structures (e.g. podiums, rostrums, LED walls etc.) have to be inspected and approved by Spielwarenmesse eG. Under certain circumstances the cavities underneath stages and podiums need to be monitored by VdS-certified smoke alarms (see Item 4.6).

Depending on the type of event and the risk from technical structures, suitably qualified personnel (stage and studio professionals) are to be appointed.

During musical, acoustical or stage performances, the **noise level at the stand edge** may not exceed **70 dB (A)**. Any threat to the hearing sense of visitors in the stand area must be ruled out.

Additional information regarding musical performances, presentations, acoustical or optical demonstrations at the exhibition stand can be found in 4.7.7 and 5.13.

5.10. Radiation protection

Information about radiation protection can be obtained from the DGUV and the responsible trade inspectorate.

5.10.1 Radioactive substances

The handling of radioactive substances is subject to permission and must be additionally approved by Spielwarenmesse eG. Spielwarenmesse is under no obligation to grant its approval. According to the

Radiation Protection Regulations (StrlSchV), approval is to be applied for from the Bavarian State Environmental Protection Office (LfU) and submitted to Spielwarenmesse eG by the specified deadline (see 4.2). The purpose of working with radioactive substances must be clearly stated in the application. If approval already exists, evidence must be provided that the intended handling of radioactive substances in the exhibition grounds is legally permitted.

5.10.2 X-ray systems and stray radiation sources

The operation of X-ray systems and stray radiation sources is subject to permission and must be additionally approved by Spielwarenmesse eG. The current Radiation Protection Regulations (StrlSchV) and the Radiation Protection Act (StrlSchG) must be observed. The operation of X-ray systems and sources of stray radiation is subject to approval or notifiable in accordance with StrlSchG. The authority responsible for the exhibition grounds is the Nuremberg Trade Inspectorate and applications must be submitted in writing on time (see Item 4.2 and also Instruction Sheet **i4.11 "X-ray systems and stray radiation sources"**).

X-ray facilities and stray radiation sources requiring permission must be inspected by an expert at the place of installation in the Exhibition Centre. The inspection report must be submitted to the government authority and Spielwarenmesse eG.

Stray radiation sources that are expressly approved for portable demonstration use outside of X-ray rooms according to the up-to-date test report do not need to be tested after installation at the exhibition stand.

The exhibitor must ensure the presence of a radiation protection officer during operation. Machinery and equipment must be secured against unauthorized entry and may only be operated by trained and instructed personnel. The permission of the government authority or confirmation of registration of the X-ray system, the inspection report and technical qualification verification of the radiation protection officer must be kept on hand in the stand.

5.10.3 Laser systems

The operation of laser systems is subject to permission and must be approved by Spielwarenmesse eG. (see Instruction Sheet **i4.10 "Operation of laser systems"**). Notification is to be accompanied by a written order for the appointment of a laser safety officer for operation of the laser system and proof of appropriate liability insurance. In addition, the exhibitor must prepare a **risk assessment for the demonstration and operation of the laser system** and submit it to Spielwarenmesse eG in advance. The operation of laser systems is to be notified to the responsible authority in accordance with § 5 of the Accident Prevention Regulation "Laser Radiation" (German DGUV Regulation 11 and 12).

The requirements of the Occupational Safety Regulation on Artificial Optical Radiation 2006/25 EC/OSrV, **TROS Laser**, DIN EN 60825-1, DIN EN 12254 and in the **case of show lasers DIN 56912** must be met. For show laser systems, the indications of DGUV Information 203-036 and 203-037 must be additionally observed. **Class 3R, 3B or 4** devices/systems must generally be inspected on site by an officially appointed expert and declared safe before use. A copy of the inspection report is to be submitted to Spielwarenmesse eG.

If changes are made to the laser system following inspection by the officially appointed and sworn expert, the operating permit becomes void. Spielwarenmesse eG is then entitled to switch off the power supply to the stand or to confiscate and secure the laser system.

When adjusting and operating the laser equipment technical and organizational measures must be taken to ensure that no-one is exposed to laser radiation in excess of the maximum admissible limits (MAR limits). The protective measures defined in the threat assessment prepared in advance must be implemented. A laser safety officer is to be provided and nominated in writing by the exhibitor. When demonstrating laser devices it must be ensured that no uncontrolled reflected radiation can occur and that the laser and/or projection area is not accessible to anyone. Protective devices or enclosures may not be removed or manipulated.

The operation of **laser processing machines** (e.g. cutting, inscribing, engraving) requires the approval of Spielwarenmesse (see 4.2). DIN EN 11553-1 must be observed and hazards posed by emissions of airborne hazardous substances (e.g. smoke or dust) must be assessed by the exhibitor in a risk assessment. The extraction and filter system must be selected in accordance with DIN EN 1093-1 and TRGS 560.

The authority responsible for industrial safety is the Nuremberg Trade Inspectorate. (see Instruction Sheet **i4.10**).

5.10.4 LEDs

Spielwarenmesse eG must be notified by the specified deadline (see Item 4.2) of the operation of high-power or high-intensity LED systems, and/or spotlights in Risk Groups 2 and 3. **LED walls/video walls** and their stability generally have to be inspected and approved by Spielwarenmesse eG (see Item 4.2.1). Suitable extinguishing equipment must be kept in readiness in the immediate vicinity of all LED systems. The operation of high-intensity LED spotlights or LED walls must not cause an annoyance to other exhibitors. Please observe Item 4.7.7 in the case of presentations and musical reproduction.

5.11 High-frequency equipment, radio installations, electromagnetic compatibility and harmonics

The operation of high-frequency equipment and radio systems must be reported to the Federal Network Agency in accordance with the Telecommunications Act and authorized by Spielwarenmesse eG. The frequency ranges and transmission power must be notified to achieve an even distribution of frequencies and prevent mutual interference as far as possible. The operation of high-frequency equipment and radio systems is only permitted if they comply with the provisions of the Telecommunications Act (TKG) and the Electromagnetic Compatibility Act (German EMVG). If exhibits are displayed or stand decorations used that involve electric, magnetic or electromagnetic fields, the provisions of the 26th Regulation on the Implementation of the Federal Immission Control Act (26 VImSchV), the DGUV Regulation 15, and the DGUV Rule 103-013 the DGUV Regulation 15, and the DGUV Rule 103-013 are to be observed. Sources of strong magnetic fields must be notified to Spielwarenmesse eG specifying the location on the respective stand.

The electrical installations of the exhibits and stands are to be designed to prevent unacceptably large interference with the network through harmonics in the exhibition center supply network (see Item 5.3.3).

Bundesnetzagentur (Federal Network Agency)
Außenstelle Nürnberg
Breslauer Straße 396, 90471 Nürnberg
Tel. +49 911 980-40, Fax +49 911 980-4180
poststelle@bnetza.de
www.bnetza.de

5.12 Cranes, forklift trucks, empty containers

The operation of exhibitors' own cranes and forklift trucks is not permitted. Only equipment supplied by the appointed ServicePartner may be used in the exhibition grounds.

The responsible ServicePartners exercise sole forwarding rights in the exhibition grounds, i.e. the delivery of exhibits, stand structures etc. to the stand, incl. provision of any auxiliary equipment and customs handling for temporary or permanent importation. Orders placed with the forwarding agents are subject to the current edition of the General German Forwarding Conditions (German ADSp) and the Forwarding Tariff for Trade Fairs and Exhibitions at Spielwarenmesse eG.

Any liability of Spielwarenmesse eG for all risks arising out of the work of the forwarding agents is excluded.

The storage of any kind of empty containers, full containers or combustible materials of any kind (e.g. packaging, packaging materials, cases) on the stands, in the gangways or in free areas not approved as storage areas is prohibited. Empty containers are to be removed to the empties storage location by the forwarding agents approved for the exhibition grounds without delay.

Obstructing the fire brigade access roads, wall hydrants, fire doors and escape routes with filled/empty containers or waste is strictly prohibited (see Item 2.). Spielwarenmesse eG reserves the right to have illegally deposited filled/empty containers removed by the approved forwarding agents at the cost of the exhibitor.

5.12.1 Displaying heavy and bulky exhibits and machines

To ensure smooth transport of heavy and bulky items during the assembly and dismantling phase, timely consultation with the responsible forwarders (ServicePartner) is necessary.

If your **item being delivered measures more than 3.00 m x 2.50 m x 4.00 m or exceeds a total weight of 5.0 t**, you must notify the responsible ServicePartner of the forwarding company at least 28 days in advance.

If necessary the delivery must be made on the first day of assembly or in special cases during assembly that has been brought forward. This must be agreed in advance with Spielwarenmesse eG.

When erecting the exhibits please observe the maximum admissible floor loads in the halls. To avoid excessive foundation pressure concentrated

loads have to be distributed via load-distributing floor panels, so that the maximum admissible area loading is not exceeded. Supply ducts and covers must be covered with suitable floor panels to prevent loads on them.

If floor anchors are needed for the secure presentation of your exhibits, please note the requirements of 4.7.4.

5.13 Musical reproduction

According to the legal provisions (German Copyright Act, **UrhG**), permission is required, where applicable, from the Society for Musical Performance and Mechanical Reproduction Rights (German GEMA) for any form of musical and audio-visual reproductions. Unregistered musical reproduction can lead to claims for damages from GEMA under (§ 97 Copyright Act, **German UrhG**).

Applications and inquiries are to be sent to:

GEMA KundenCenter
11506 Berlin
Tel. +49 3 05 88 58-9 99
kontakt@gema.de
www.gema.de

Acoustic and visual demonstrations also require approval by Spielwarenmesse eG. Approval is granted on condition that the loudness at the edge of the stand during operation of the system does not 70 dB(A) and the measures to prevent the risk of hearing loss of the audience according to DIN 15905 (Part 5) are observed. Furthermore, it must be demonstrated here that there is enough room for spectators on the stand surface. It must be ensured that the demonstrations/advertising measures do not cause any blockages, interference or congestion in the passageways. The demonstrations must not have any adverse impact on neighbouring stands and other exhibitors and any health hazard/risk of hearing loss for visitors or employees must be ruled out.

In the event of repeated failure to comply with these rules, the power supply to the exhibitor's stand can be interrupted without regard to the associated effects of the power failure. The exhibitor shall not be entitled to claim for direct or indirect damage caused by the interruption of the power supply.

It is the responsibility of the exhibitor to provide evidence of compliance with the regulations. Media equipment is to be placed far enough away from the edges of the stand so that interested visitors must enter the stand and do not obstruct visitor traffic in the gangways.

5.14 Beverage dispensing systems

Beverage dispensing systems on the stand are to be installed and operated in accordance with the Operating Safety Regulations, DGUV Rule 100-007 and DIN 6650-6.

Compliance with technical and food hygiene requirements must be demonstrated by the exhibitor and may be checked by the Public Order Office.

This results in a documentation obligation regarding the exhibitor's aforementioned duty of monitoring and care to ensure compliance with technical and food hygiene requirements of the entire system. Furthermore, food hygiene regulation No. 852/2004 dated 29 April 2004 of the European Parliament and Council will apply.

Notice of the use of pressurized gas containers must be submitted to Spielwarenmesse eG (see Item 5.7).

5.15 Handling foods

The serving of samples for immediate consumption and the sale of food and drinks on the stand must conform to the currently valid statutory regulations and the current standards, especially the Food Hygiene Regulations (LMHV; Directive (EU) No. 852/2004) and the Food Information Regulations (LMIV; Directive (EU) No. 1169/2011).

For further information please contact
Stadt Nürnberg – Ordnungsamt - Abteilung Lebensmittelüberwachung
Innerer Laufer Platz 3, 90403 Nürnberg
Tel. +49 911 231-2524, Fax +49 911 231-3070
lebensmittelueberwachung@stadt.nuernberg.de
www.ordnungsamt.nuernberg.de

The provision of food and beverages against payment by the exhibitor and external catering service providers who are not ServicePartners of NürnbergMesse GmbH is not permitted at the Spielwarenmesse® (including the exhibitor's stand); This does not include the free delivery of food and beverages for the purpose of customer entertainment on the exhibitor's rented stand area. The hygienic and legal regulations must be strictly adhered to.

5.15.1 Requirements for stand/kitchen facilities

The kitchen facilities absolutely must comply with the following requirements:

- If mobile food service or kitchen facilities (e. g., **food trucks, snack vans, trailers**, etc.) are to be used, they must be approved by NürnbergMesse (see 4.2).
- Hand-washing facility with running hot and cold water with liquid soap and disposable hand towels must be provided.
- Crockery and glasses must be washed with running hot and cold water and/or a dishwasher is to be provided.
- Smear-resistant floor coverings, washable wall coverings and storage areas are to be provided in food preparation and storage areas.
- The floors in the work area must be non-slip, flat and impermeable to liquids.
- Effective spittle/sneeze guards must be installed in the food service area.
- Functioning cooling equipment for perishable food.
- Install effective exhaust air systems or extractor hoods with active charcoal filters if vapors or odours can be expected when food is being prepared or kept warm.
- Provide suitable number of portable fire extinguishers (to EN3, foam extinguishers or extinguishers for cooking oils and fats). At least one cooking oil/fat fire extinguisher and fire blanket for each cooking area (fire classification F to DIN EN2).

5.15.2 Cooking appliances and food preparation processes

Cooking equipment (e. g. deep fat fryers, fryers, large frying pans etc.) may only be electric and must be operated under supervision in the halls following notification to Spielwarenmesse eG.

At the end of each day of the event the appliances must be switched off at the mains. The mains switch must be clearly marked EMERGENCY OFF switch.

Cooking appliances and equipment must not be installed in traffic routes at the stand or directly next to hall gangways. **A minimum distance of 1.5 m** is to be observed.

Deep-fat fryers or similar equipment must not be used in the top storey of multi-storey stands. For fire safety reasons when using deep fat fryers a non-flammable canopy must be provided so that in the event of a hot grease fire there is no effect on the hall sprinkler system. The maximum filling level is 40 l (filling level of adjacent appliances to be added up). If the maximum level is going to be exceeded this must be discussed with Spielwarenmesse eG beforehand. When using pressure cookers, hot air convection ovens or similar appliances using **steam**, such as combination steamers or convection ovens, a suitable air extractor and/or condensation hood must be provided above the appliance. Alternatively, appliances with integrated extraction systems may be used. In general it must be ensured that no hot steam, vapors or fumes can escape into the hall. In other respects the provisions of DGUV Regulations 110-002 are to be observed. In covered areas of multi-storey stands fitted with a temporary sprinkler system, smoke or differential or heat detectors, the use of the appliances described above must be agreed with Spielwarenmesse eG beforehand (see Item 4.2). The costs associated with all false alarms caused by the handling of cooking appliances will be billed to the perpetrator.

5.15.3 Grilling/barbecuing

Grilling/barbecuing in the halls and outdoor area is allowed subject to the prior written permission of Spielwarenmesse eG.

If written permission is given, only electric grills/barbecues may be used inside the halls and the vapors/smoke must be discharged outside using suitable exhaust systems.

6. Environmental protection

Spielwarenmesse eG is committed to pro-active protection of the environment. As contractual partner of Spielwarenmesse eG, the exhibitor is obliged to ensure that all binding regulations and standards concerning environmental protection are also observed by his contractors (e. g. stand builders).

6.1 Waste management

All the following rules are based on the currently valid requirements of the Recycling Management Act (German KrWG), the associated implementation provisions and regulations, particularly including the Commercial Waste Regulations (German GewAbfV), the "state laws" and "local government by-laws".

The city of Nuremberg has issued a by-law on waste management which governs waste prevention and waste sorting and is binding on exhibitors and organizers.

The exhibitor is responsible for proper and environmentally compatible disposal of waste produced during assembly and dismantling and during the event by it or its contractors (e. g. stand builders, caterers, etc.). The exhibitor is the producer of this waste. The technical handling of disposal for recycling and removal is solely incumbent on Spielwarenmesse eG or its appointed ServicePartner.

6.1.1 Waste disposal

According to the German Waste Management Act, the German Commercial Waste Regulation (GewAbfV) and the Waste Framework Directive (Directive 2008/98/EG with amendments by Directive (EU) 2018/851), waste should be primarily avoided during assembly and dismantling and during the event. Exhibitors and their contractual partners are obliged to effectively contribute to this in every phase of the event. This aim must be pursued by all concerned in the planning and coordination phases. This especially applies to packaging material, advertising material, carpets, disposable stand equipment, empty containers, pallets and disposable crockery. Please particularly observe the ban on the use of swabs, cutlery, plates, straws, stirrers and balloon poles made of plastic. The ban also applies to disposable cups and disposable packaging made of expanded polystyrene (styrofoam).

Exhibitors are responsible for the daily disposal of waste from their stand spaces during the event and for the disposal of waste produced during assembly and dismantling. In order to meet exhibitors' aforementioned obligations, Spielwarenmesse eG uses the services of an official ServicePartner to ensure waste is disposed of correctly. The requirements of the Commercial Waste Ordinance (Gewerbeabfallverordnung) are met when the waste disposal is handled by the ServicePartner appointed by Spielwarenmesse eG. The disposal costs for exhibitors which arise in relation to this are covered by payment of the waste disposal fee as per the Rules for exhibitors. The disposal of production waste and fair stands is excluded from this. If waste is not or not completely disposed of in this case, Spielwarenmesse eG will appoint the official ServicePartner to perform this work at the cost of the respective exhibitor. The amount of any waste remaining in the halls will be estimated in m³ without checking the value and the exhibitor charged for its disposal at the higher official price.

The disposal of waste in waste containers or in other facilities of the Nuremberg exhibition grounds is expressly prohibited.

Exhibitors are obliged to hand over their stand spaces in a clean condition at the end of the event. This particularly applies to materials left on the hall floor (e. g. remains of adhesive tape etc.). See also Item 4.7.4. Please co-operate – think of the environment!

6.1.2 Hazardous waste

The exhibitor and exhibitor's contractual partners (e. g. stand builders) are obliged to notify Spielwarenmesse eG of waste whose type, property or quantity is especially hazardous to health, air or water, explosive or combustible (e. g. batteries, coatings, solvents, lubricants, paints, etc.) and to arrange their proper disposal by the responsible ServicePartner.

6.1.3 External waste

Materials and waste not produced in connection with assembly and dismantling or the duration of the event are not to be brought into the exhibition grounds.

6.2 Water, waste water, soil protection

6.2.1 Oil and grease separators

The amounts discharged into the waste water network must not exceed the level of pollutants deemed normal for households.

If waste water containing oil or grease exceeding these levels is to be discharged, oil and grease separators must be used. These must comply with generally accepted engineering practice.

If mobile catering units are used, fats and oils must be collected and disposed of separately.

6.2.2 Cleaning, cleaning agents

The exhibitor is obliged to hand over his stand space in a clean condition at the end of the event. This particularly applies to materials left on the hall floor.

All cleaning work is to be done using biologically degradable products. If products classified as hazardous substances are used, Item 5.8 must be observed. Spielwarenmesse eG cleans the traffic areas and other areas unless they were made available to exhibitors or other third parties. The exhibitor is responsible for cleaning the exhibition stand.

Cleaning must be completed every day before the end of the exhibition or event. The official ServicePartner of Spielwarenmesse eG can be hired to clean the stand in the Online Service Center.

6.3 Environmental damage

Environmental pollution/contamination (e.g. through petrol, oil, solvents, paint) is to be reported to Spielwarenmesse eG without delay. Spielwarenmesse eG will arrange for this to be removed properly at the cost of the perpetrator.

Note:

If required the Instruction Sheets can be requested at standbau@spielwarenmesse.de

Instruction Sheet

“Suspension points, trusses and lifting equipment” 2023

The suspension of objects from the hall ceiling, the provision of suspension points and the modification of suspension constructions are carried out exclusively by NürnbergMesse through its appointed ServicePartners.

Suspension points must be ordered in writing from the Exhibitor Service Dept. of NürnbergMesse using Form S2.15. The construction to be suspended must be located within the stand boundaries. The **maximum vertical purely structural load capacity** of each suspension point on the ceiling construction is **25 kg (0.25 kN)** for halls **1, 2, 3, 4, 5, 6, 7, 8, 9, 10 and 12**.

In halls **3A, 3C, 4A, 7A and 11**, the **maximum vertical structural load capacity is 240 kg (2.4 kN)**.

Higher loads are only possible on request via the Event Technology Department and after structural inspection by an engineer appointed by NürnbergMesse.

The exhibitor or client will be charged for the cost of such a structural inspection.

The **provision of suspension points cannot be guaranteed in all areas**.

This applies mainly to the peripheral areas of the following halls:

Halls 3A, 3C and 11.0:

No suspension points can be provided over the exhibition areas in the area of the loading yard gates with limited headroom. The necessary minimum distances from the sprinkler heads must also be strictly observed in these areas (see Technical Regulations Item 3.1.4). Information on the reduced bearing load of suspension points in the peripheral areas of halls 3A and 3C can be obtained from the responsible ServicePartner.

Halls 4A and 7A:

Only a few suspension points with a reduced bearing load are available in the exhibition areas in the area of the loading yard gates with limited headroom. The application of dynamic loads and the use of lifting equipment here are permitted only after consultation with and approval by the responsible ServicePartner.

NürnbergMesse reserves the right to require the installation of load measuring systems in the case of statically indeterminate systems. The load measuring systems are to be supplied, installed and operated exclusively by the responsible ServicePartner. The costs of the load measuring systems will be billed to the ordering party. We would like to advise that the use of load cells can reduce the maximum suspension height by up to 50 cm.

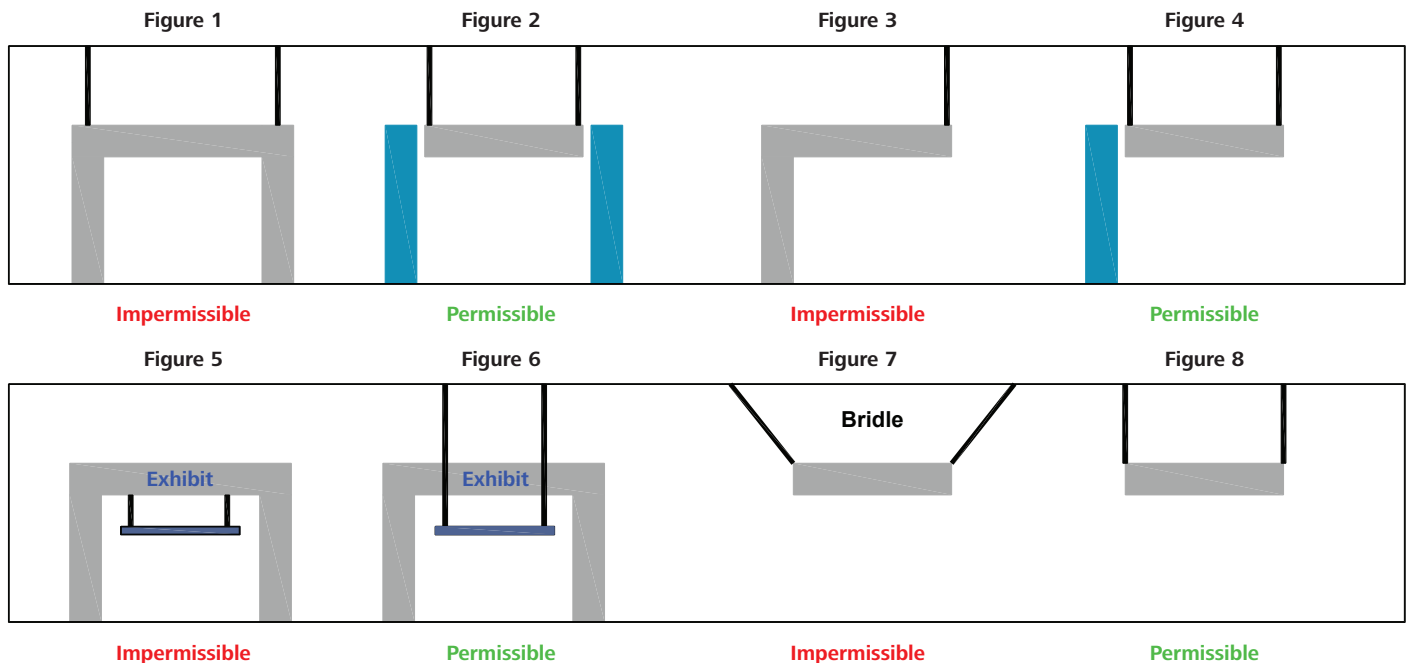

The following types of suspension are not permitted for safety reasons:

- Suspended constructions with a rigid or non-positive connection to the hall floor (see Figures 1 and 2)
- Suspension points used for securing stand components or exhibits (stand components or exhibits must stand securely on their own, see Figures 3 and 4)
- Suspension from exhibits (see Figures 5 and 6)
- The use of bridle suspension points is not permitted on the NürnbergMesse site (see Figure 7)

The use of lifting equipment (electric chain hoists, manual chain hoists, sling hoists) is only possible in halls 3A, 3C, 4A, 7A, 11 and NCC Ost and must be agreed with NürnbergMesse/Event Technology Department.

The provision and use of attachment gear, load-bearing equipment, lifting equipment, load-bearing lines, fasteners, rope terminations, secondary safety equipment and equipotential bonding must comply with the relevant safety regulations and the recognized rules of engineering. The following regulations issued by the various German associations apply:

DGUV Regulation 1 – Principles of Prevention,
 DGUV Regulation 17 – Staging and Production Facilities for the Entertainment Industry,
 DGUV Regulation 54 – Winches, Lifting and Hoisting Equipment,
 DGUV Information 215-310 Guide to Safety at Productions and Events,

DGUV Information 215-313 Safety at Productions and Events – Loads Suspended above Persons

DGUV Information 215-314 Spotlights

DGUV Information 215-315 Special Stage Effects and Operations

IGWW SQP1 “Trusses”

IGWW SQP2 “Electric Chain Hoists”,

IGWW SQP4 “Mobile electrical equipment in event technology”,

IGWW SQP5 “Erection and operation of non-stationary stages and stage coverings”.

IGWW SQQ1 “Event Electrician”,

IGWW SQQ2 “Event Rigging Expert”

IGWW SQQ2 “Event rigging – Organisation and work methods”

Bavarian Venue Regulations (German: Bay. VStättV)

The following information on attachment gear, load-bearing equipment, lifting equipment, fasteners, rope terminations and secondary safety components is intended as a guide and is not exhaustive.

Attachment gear:

The maximum load on ropes and slings must not exceed one-tenth of the minimum breaking load. The maximum load for other attachment gear is half the manufacturer’s specified working load limit (WLL). Any dynamic forces occurring must be given special consideration (dynamic factor).

“Suspension points, trusses and lifting equipment” 2023

(continued)

The edge radius for attaching loads must be greater than the nominal diameter of the attachment gear (rope, webbing sling and round sling). No further load reduction is necessary for an edge radius of more than three times the nominal diameter of the attachment gear. The heat resistance of attachment gear varies. Webbing slings and round slings made of man-made fibers (PA, PES) and wire ropes with fiber cores (ferrule and thimble) are only to be used up to 100 °C and are not suitable for use close to spotlights. Webbing slings and round slings made of polypropylene (PP) are only designed for use up to 80 °C and therefore even less suitable. Wire ropes with steel cores (ferrule and thimble) are suitable for use at temperatures up to 150 °C.

Permissible attachment gear:

- Attachment ropes of steel wire with fiber or steel cores, ferrules and thimble rope terminations, and rope grade 1960 (corresponds to a minimum rated wire strength of 1770 N/mm²) to DIN EN 12385-4, Table 7 (rope class 6 x 19 for ropes ≥ 6 mm), Table 12 (rope class 6 x 19 M for ropes of 3 mm to 5 mm), DIN EN 13414-1, Table 3 and 4 (ropes ≥ 8 mm)
- Rope terminations must comply with DIN EN 13411-1 (thimbles) and DIN EN 13411-3 (ferrules)
- Short-link sling chains of quality grade 8 (DIN 5688-3) or higher, with a breaking strength ≥ 20 %
- Webbing slings and round slings made of man-made fibers to DIN EN 1492-1, DIN EN 1492-2 with marking and using a secondary safety component comprising a steel rope with thimble, ferrule and fastener (to DIN 56927)
- Wire rope round sling with sheath of man-made fibers (“steelflex”)
- Aluminum or steel clips and truss adapter approved for the respective trusses (accessory), with marking (indicating load capacity and safety coefficient)

Impermissible attachment gear:

- Wire ropes not conforming to the above requirements
- Wire ropes with sheath (sheath > 1/3 of rope length)
- Long-link sling chains (inside length of chain link (pitch) > 3 x nominal diameter of chain material)
- Untested short-link sling chains or short-link lifting equipment chains (these must not be used as sling chains, as they have a breaking strength of only 5 to 15 %)
- Cable ties, pipe clips or perforated tape without the use of a secondary safety component comprising a steel wire rope with thimble, ferrule and fastener (DIN 56927)
- Webbing slings and round slings made of man-made fibers, without marking and indication of load capacity
- Webbing slings and round slings made of man-made fibers to DIN EN 1492-1, DIN EN 1492-2 with marking and indication of load capacity, BUT without the use of a secondary safety component comprising a steel wire rope with thimble, ferrule and fastener (DIN 56927)
- Damaged attachment gear (e.g. kinked ropes, slings with damaged sheath and sling without recognizable marking)
- One-sided load pickups at trusses with two upper chord (e.g. four-point trusses) are not permitted since this could cause an additional loading of the trusses through torsion. Deviations from this must be accompanied by a structural loading certificate and agreed upon beforehand with NürnbergMesse (Exhibition Technology Department)

Permissible load-bearing equipment:

- Aluminum trusses to DIN EN 1999-1-1, DIN EN 1999-1-1/NA, IGWW SQP1 “Trusses”
- Steel trusses to DIN EN 1090-2, DIN 18800-7, IGWW SQP1 “Trusses”

Permissible and **impermissible** positions for installing trusses without additional structural safety certificate:

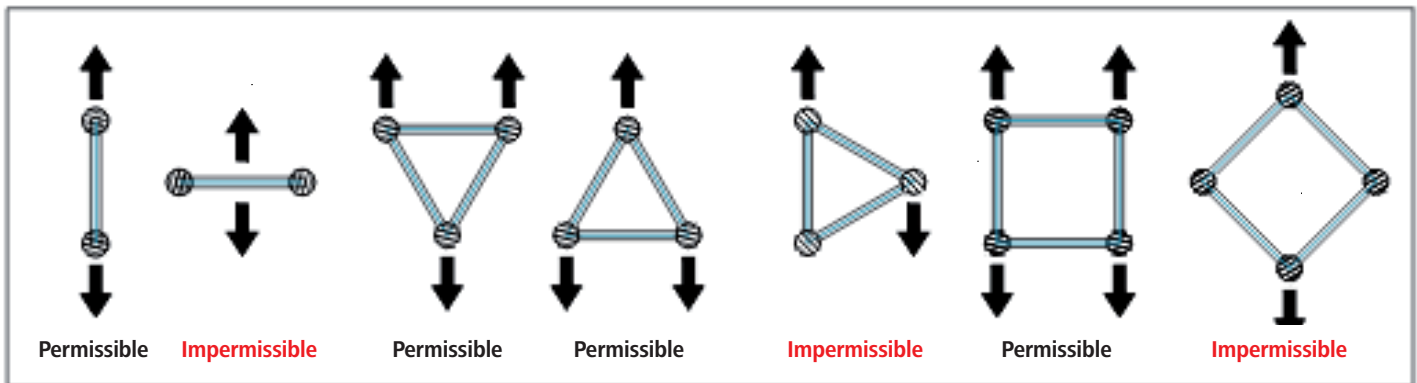

Impermissible load-bearing equipment:

- Trusses not conforming to the requirements of SQP1 “Trusses” and DIN EN 1999-1-1, DIN EN 1999-1-1/NA, DIN EN 1090-2, DIN 18800-7
- Trusses without a structural test certificate
- Trusses without marking
- Trusses those are no longer safe for use, i.e. damaged or worn (this also includes damage like dents, cracks, drill holes or other changes)
- Trusses without end struts, if the framework is ignored
- Trusses not used for their intended purpose, e.g. screwed to stand walls, on stand walls, frames, truss tower with base plates that are too small and/or too little ballasting
- Truss systems put together out of different types (manufacturers, versions, models)
- Variably **bendable truss corners** (so-called **book corners**), if they are not generally mounted load-free.

Equipotential bonding of truss systems¹

Truss systems that may carry hazardous contact voltages in the event of a fault must be incorporated in a common equipotential bonding system. This applies to all elements of electrically conductive material on which electrical equipment is installed or mounted or over which lines and cables are routed which could come into contact with metal parts in the event of damage. Connection to the equipotential bonding system can be made using clips, pipe clamps, screwed fasteners or special single-pole plug-in connectors with locking device. The common equipotential bonding is to be connected to the ground conductor of the mains supply network. Suitable conductor cross-sections are 16 mm² Cu for conductor lengths of up to 50 meters and 25 mm² Cu for conductor lengths of up to 100 meters.

¹ IGWW SQP1 Provision and Use of Truss Systems, 5.3 Installation of Trusses, Equipotential Bonding on 2023 Trusses

Instruction Sheet

“Suspension points, trusses and lifting equipment” 2023

(continued)

Permissible lifting equipment:

- **C 1 hoist** Point hoist to DGUV Regulation 17, IGVV SQP2
Nominal load as specified by manufacturer
- **D 8 hoist** Electric chain hoist to DGUV Regulation 54 with secondary safety component for bypassing the electric chain hoist (incl. hooks and hoist chain)
MOVING OR HOLDING LOADS ABOVE PERSONS WITHOUT A SAFETY DEVICE IS PROHIBITED!
Nominal load as specified by manufacturer
- **D 8 Plus hoist** Electric chain hoist with secondary safety component/second brake to DGUV Regulation 54 with special features to hold loads in place above persons without secondary safety component – IGVV SQP2
MOVING LOADS ABOVE PERSONS IS PROHIBITED!
Nominal load as specified by manufacturer

Use of lifting equipment

The use of lifting equipment (electric chain hoists, manual chain hoists, etc.) is only possible in halls 3A, 3C, 4A, 7A and 11 requires prior approval by NürnbergMesse.

The use of lifting equipment (electric chain hoists, manual chain hoists, etc.) in halls 1, 2, 3, 4, 5, 6, 7, 8, 9, 10 and 12 is strictly prohibited!

The use of lifting equipment is governed by the requirements and implementation instructions of DGUV Regulation 17, DGUV Information Sheet 215-313 and the industry standard SQ .

A suitable rope termination (e.g. ring or rope socket) must be provided.

Cable holders (sliders) are only designed for static loads and must not be used in conjunction with lifting gear.

The use of lifting gear must be advised when ordering suspension points!

Electric chain hoists – general information

Electric chain hoists may only be used in halls with heavy duty suspension devices (**halls 3A, 4A, 7A and 11**).

The use of this lifting gear is subject to the Requirements for Electric Chain Hoists in Event Technology (IGVV SQ P2).

The dead weight of the electric chain hoists and dynamic coefficients must be taken account of in the load plan so as not to overload the slinging points.

The contractor must subject the hoists to an annual expert inspection. The test certification mark must be affixed to a visible location on the lifting equipment and the test documentation has to be available on site at all times. This inspection does not replace the inspection by an officially appointed expert every four years.

Manual chain hoists – general information

Manual chain hoists may only be used in conjunction with heavy-duty suspension devices (hall 3A, 3C, 4A, 7A and 11).

Manual chain hoists may only be used in the case of statically determinate systems, i.e. a line load on two hoists or a distributed load on three hoists. The use of manual chain hoists for complex systems is not admissible.

The carrying and load hook of the hoist must be in a perpendicular straight line above the centre of gravity of the load. Winding round the load with the chain (carrier) or guiding the load chain over corners is not admissible. Loads must always be moved with all attached manual chain hoists at the same time, i.e. there must be as many people lifting at the same time as there are manual chain hoists in use. It must be ensured that the lifting and lowering processes are uniform.

The dead weight of the manual chain hoists and dynamic coefficients must be taken account of in the load plan so as not to overload the slinging points.

Impermissible lifting equipment:

- Electric chain hoists to DGUV Regulation 54, without secondary safety component
- Electric chain hoists to DGUV Regulation 54 with inadequately rated secondary safety component (see Permissible secondary safety components)
- Untested electric chain hoists or electric chain hoists without test certificates (annual inspection; for C1 and D-Plus hoists: plus expert inspection every 4 years)
- Electric chain hoists showing obvious signs of damage
- Electric chain hoists not used for their intended purpose (see IGVV SQP2, e.g. stage use of an electric chain hoist to DGUV Regulation 54)

Permissible fasteners:

The nominal load is half the manufacturer's specified load-bearing capacity, maximum one-tenth of the minimum breaking load.

- Shackles, straight and curved, grade 6, to DIN EN 13889 with marking, with type X threaded bolt (with hexagonal head, hexagonal splint nut) if used with dynamic loads (e.g. for suspension of loudspeakers)
- High-strength shackle, grade 8, to DIN EN 1677-1
- Quick link for operation of lifting equipment, non-standard (safety factor 5), marked with load-bearing capacity
- Quick link for event equipment (safety factor 10) to DIN 56927 with marking
- Turnbuckles with closed eyes to DIN 1480, marked with load-bearing capacity, only with safety splint and safety nut if used with dynamic loads
- Suspension ring/link (closed O-ring) marked with load-bearing capacity, or with manufacturer's data sheet
- Shortening clutch with safety element to prevent unintentional unhooking, e.g. locking pins

Impermissible fasteners:

- Carabiners with/without screw lock
- Open hooks
- Open turnbuckles to DIN 1480
- Quick link with lock nut, not marked with load-bearing capacity
- Lashing or tension straps as connection between two truss parts
- Shackles to DIN 82101 (have a working coefficient of only 3)
- Shortening clutch without safety element to prevent unintentional unhooking, e.g. locking pins
- Other fasteners without marking/indication of load-bearing capacity/manufacturer's data sheet

Permissible rope terminations:

- Thimble to DIN EN 13411-1 and ferrules to DIN EN 13411-3
- Rope locks (straight) to DIN EN 13411-7, for dynamic loads only with rope clamp (frog) to DIN EN 13411-5

Impermissible rope terminations:

- Rope clamps (so-called “frog clamps”) to former DIN 1141
- Rope clamps (so-called “frog clamps”) to former DIN 741

Instruction Sheet

“Suspension points, trusses and lifting equipment” 2023

(continued)

Secondary safety components:

A secondary safety component according to DIN 56927 usually consists of a wire rope, rope termination and fastener. The drop distance should be practically zero.

This is best achieved with a safety rope together with a grade 8 shortening clutch equipped with a safety element to prevent unintentional unhooking (drop distance \leq length of one chain link (pitch)).

Only quick links with cap nuts according to DIN 56927, or grade 8 high-strength shackles to DIN EN 1677-1 may be used as fasteners for a secondary safety component.

If secondary safety components with a larger drop distance than one chain pitch are used, a structural certificate may be requested for the pulse load of all components of the secondary safety component, attachment gear, load-bearing lines, fasteners and load-bearing equipment.

Permissible secondary safety components:

- Wire rope of steel wire with fiber core, ferrule sling and thimble as rope termination, rope grade 1960, to DIN EN 12385-4, Table 7 (rope class 6 x 19 for ropes \geq 6 mm), Table 12 (rope class 6 x 19 M for ropes of 3 mm to 5 mm), DIN EN 13414-1, Table 3, or to former DIN 3060 (round-stranded rope 6 x 19 standard)
- Rope terminations must comply with DIN EN 13411-1 (thimbles) and DIN EN 13411-3 (ferrules)
- Fasteners conforming to the above standards

Impermissible secondary safety components:

- Wire ropes not conforming to the above requirements
- Inadequately rated wire ropes (see DIN 56927, DGUV Information 215-313)
- Fasteners not conforming to the above requirements
- Inadequately rated fasteners (see DIN 56927)
- Rope terminations not conforming to the above requirements (e.g. rope locks)

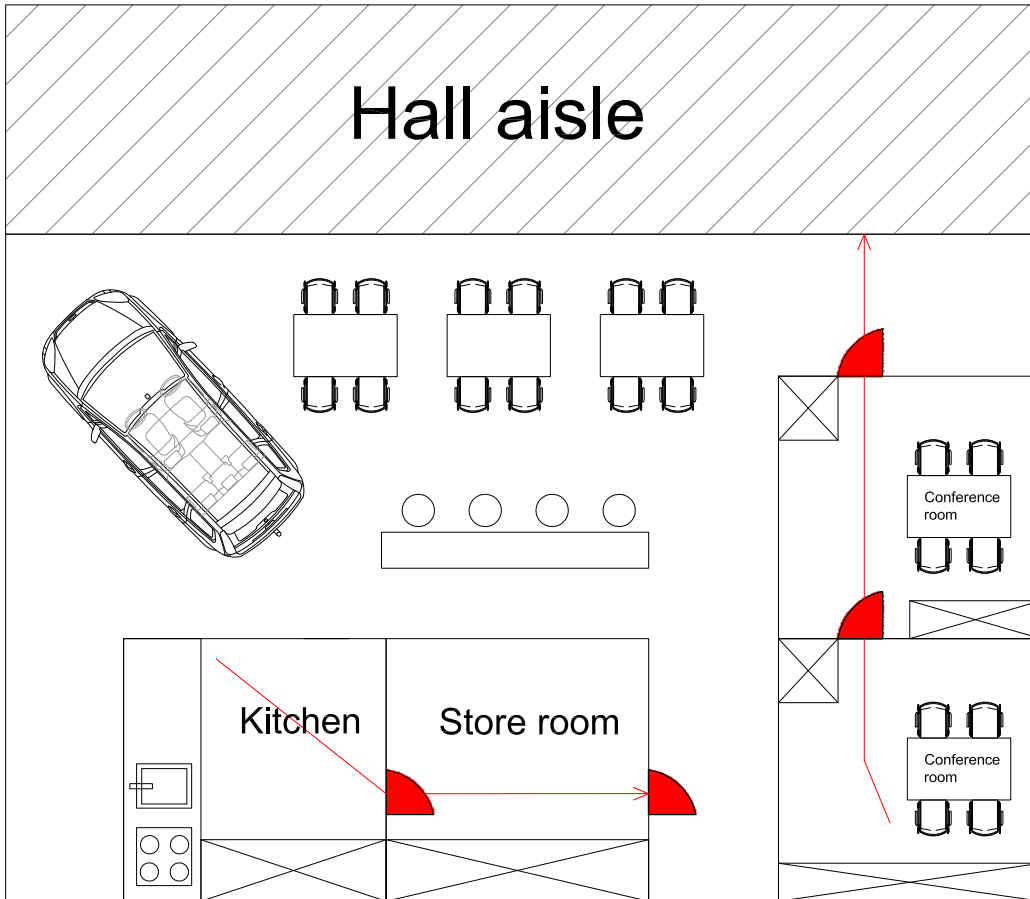

Unauthorized door positioning as the emergency escape route must be through a second room.

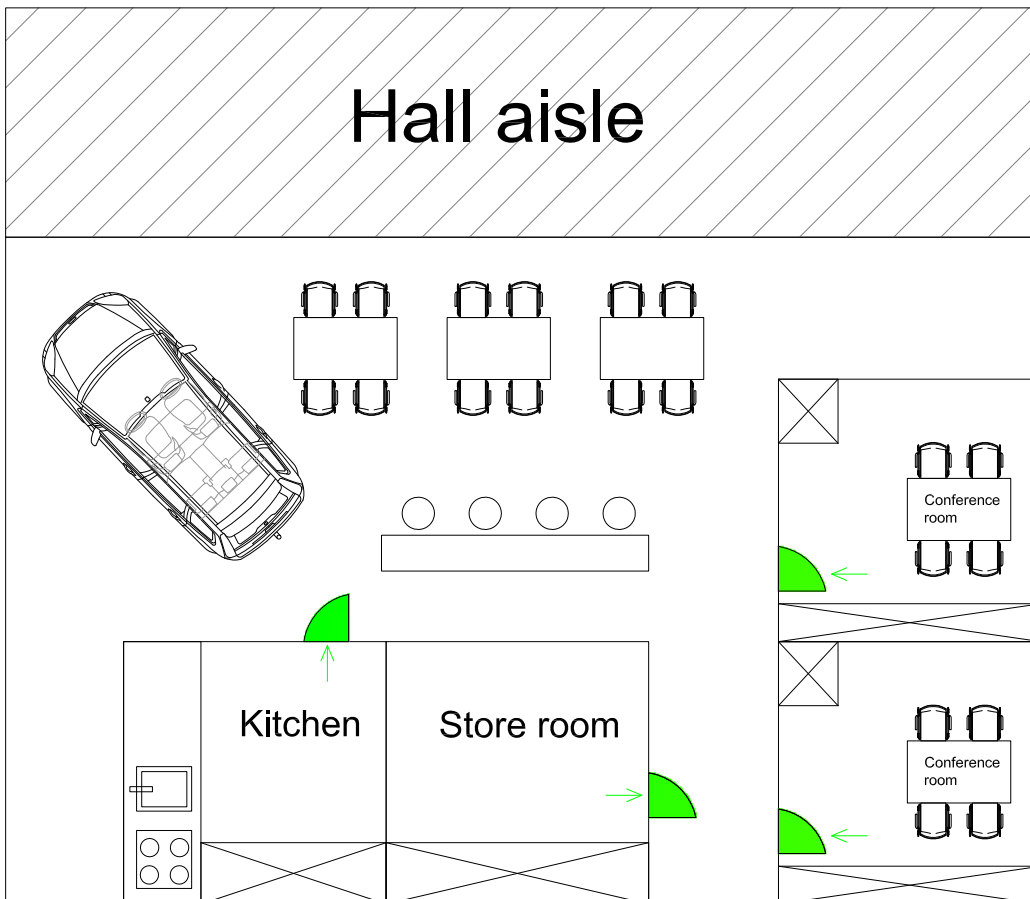

Authorized door positioning as the direct escape route is guaranteed.

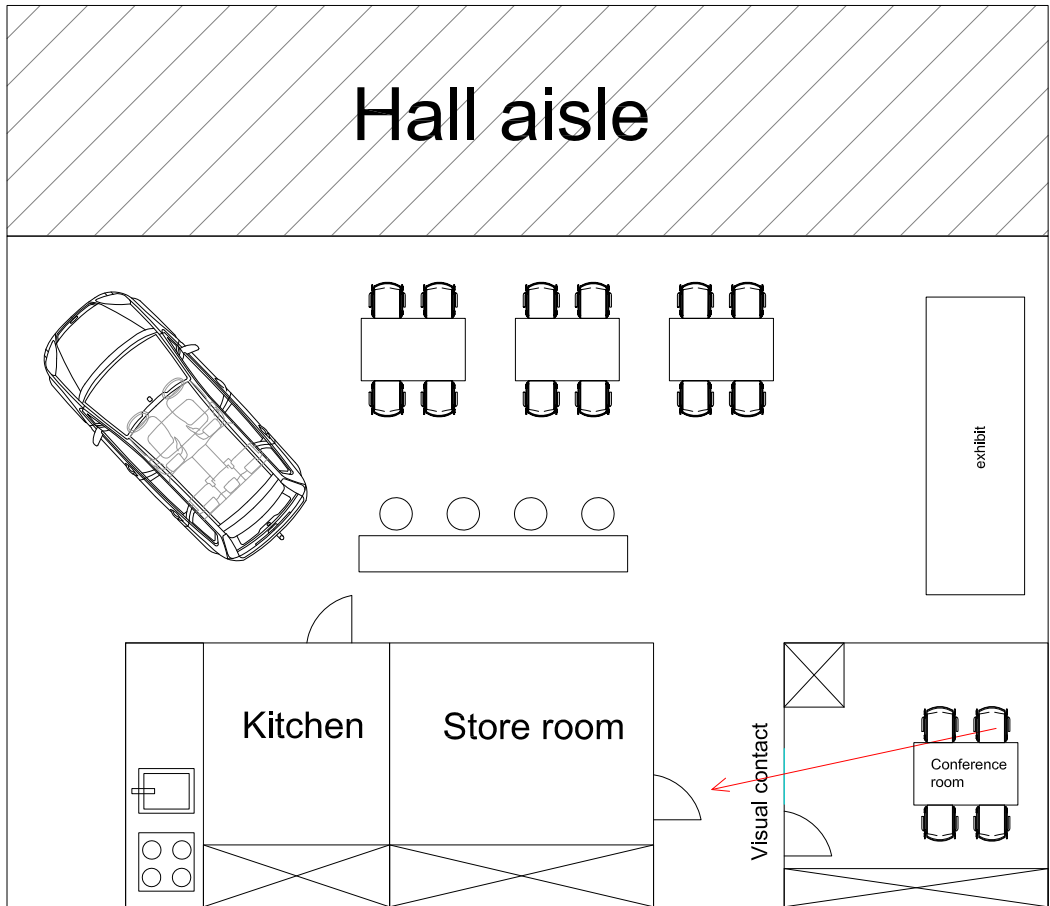

Unauthorized line sight as direct visual contact is only possible across the hallway located directly in front.

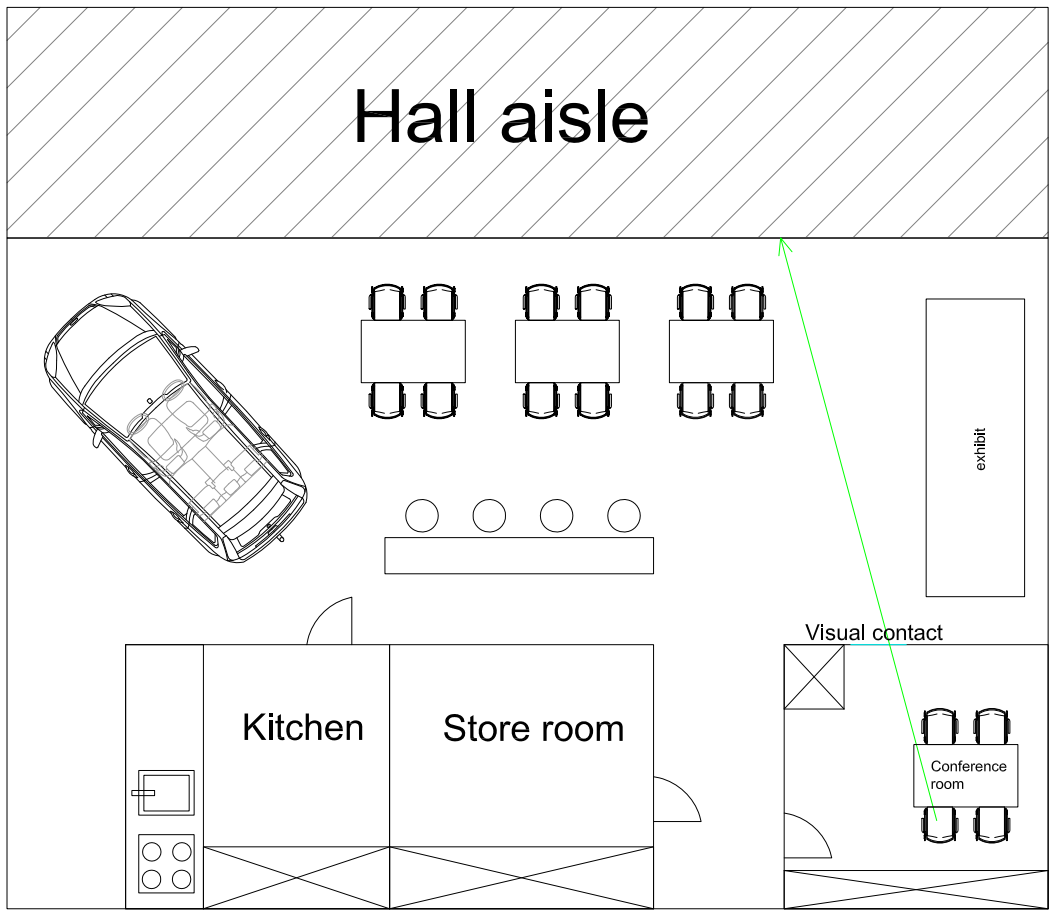

Authorized line of sight as visual contact to an essential hall aisle is directly guaranteed.

Instruction Sheet

“Fire prevention – German and European classification of building products” 2023

European classification of building products

Building authority designation	Additional requirements				Building authority designation	Additional requirements			
	DIN 4102	DIN EN 13501	Smoke production	Flaming particles/droplets		DIN 4102	DIN EN 13501	Smoke production	Flaming particles/droplets
Non-combustible	A1	A1	no/hardly	no drips/droplets	Difficult to ignite	B1	C – s1, d1	no/hardly	limited drips/droplets
Non-combustible	A2	A2 – s1, d0	no/hardly	no drips/droplets	Difficult to ignite	B1	C – s1, d2	no/hardly	many drips/droplets
Difficult to ignite	B1	A2 – s1, d1	no/hardly	limited drips/droplets	Difficult to ignite	B1	C – s2, d0	limited	no drips/droplets
Difficult to ignite	B1	A2 – s1, d2	no/hardly	many drips/droplets	Difficult to ignite	B1	C – s2, d1	limited	limited drips/droplets
Difficult to ignite	B1	A2 – s2, d0	limited	no drips/droplets	Difficult to ignite	B1	C – s2, d2	limited	many drips/droplets
Difficult to ignite	B1	A2 – s2, d1	limited	limited drips/droplets	Difficult to ignite	B1	C – s3, d0	unlimited	no drips/droplets
Difficult to ignite	B1	A2 – s2, d2	limited	many drips/droplets	Difficult to ignite	B1	C – s3, d1	unlimited	limited drips/droplets
Difficult to ignite	B1	A2 – s3, d0	unlimited	no drips/droplets	Difficult to ignite	B1	C – s3, d2	unlimited	many drips/droplets
Difficult to ignite	B1	A2 – s3, d1	unlimited	limited drips/droplets	Normal combustibility	B2	D – s1, d0	no/hardly	no drips/droplets
Difficult to ignite	B1	A2 – s3, d2	unlimited	many drips/droplets	Normal combustibility	B2	D – s1, d1	no/hardly	limited drips/droplets
Difficult to ignite	B1	B – s1, d0	no/hardly	no drips/droplets	Normal combustibility	B2	D – s1, d2	no/hardly	many drips/droplets
Difficult to ignite	B1	B – s1, d1	no/hardly	limited drips/droplets	Normal combustibility	B2	D – s2, d0	limited	no drips/droplets
Difficult to ignite	B1	B – s1, d2	no/hardly	many drips/droplets	Normal combustibility	B2	D – s2, d1	limited	limited drips/droplets
Difficult to ignite	B1	B – s2, d0	limited	no drips/droplets	Normal combustibility	B2	D – s2, d2	limited	many drips/droplets
Difficult to ignite	B1	B – s2, d1	limited	limited drips/droplets	Normal combustibility	B2	D – s3, d0	unlimited	no drips/droplets
Difficult to ignite	B1	B – s2, d2	limited	many drips/droplets	Normal combustibility	B2	D – s3, d1	unlimited	limited drips/droplets
Difficult to ignite	B1	B – s3, d0	unlimited	no drips/droplets	Normal combustibility	B2	D – s3, d2	unlimited	many drips/droplets
Difficult to ignite	B1	B – s3, d1	unlimited	limited drips/droplets	Normal combustibility	B2	E		
Difficult to ignite	B1	B – s3, d2	unlimited	many drips/droplets	Normal combustibility	B2	E – d2		many drips/droplets
Difficult to ignite	B1	C – s1, d0	no/hardly	no drips/droplets	Easily ignited	B3	F		

The following conditions apply at the NürnbergMesse site (acc. to DIN EN 13501):

- unrestricted approval
- limited approval only as a stand construction material (see Technical Guidelines 4.4.1.1)
- approved up to 2.50 m wall construction/not approved over people (d1)
- not approved (D, E, F, s3 or d2)

Key to building product classes: to DIN 4102

- A1 = non-combustible (without combustible components)
- A2 = non-combustible (with combustible components to a minor extent)
- B1 = difficult to ignite
- B2 = normal combustibility
- B3 = easily ignited

Key to building product classes: to DIN EN 13501

- A1 = non-combustible (without combustible components)
- A2 = non-combustible (with combustible components to a minor extent)
- B,C = difficult to ignite
- D,E = normal combustibility
- F = easily ignited
- s1 = no/hardly any smoke production
- s2 = limited smoke production
- s3 = unlimited smoke production
- d0 = no drips/droplets
- d1 = limited drips/droplets
- d2 = many drips/droplets

Instuction sheet "Door positioning"

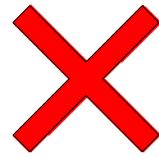
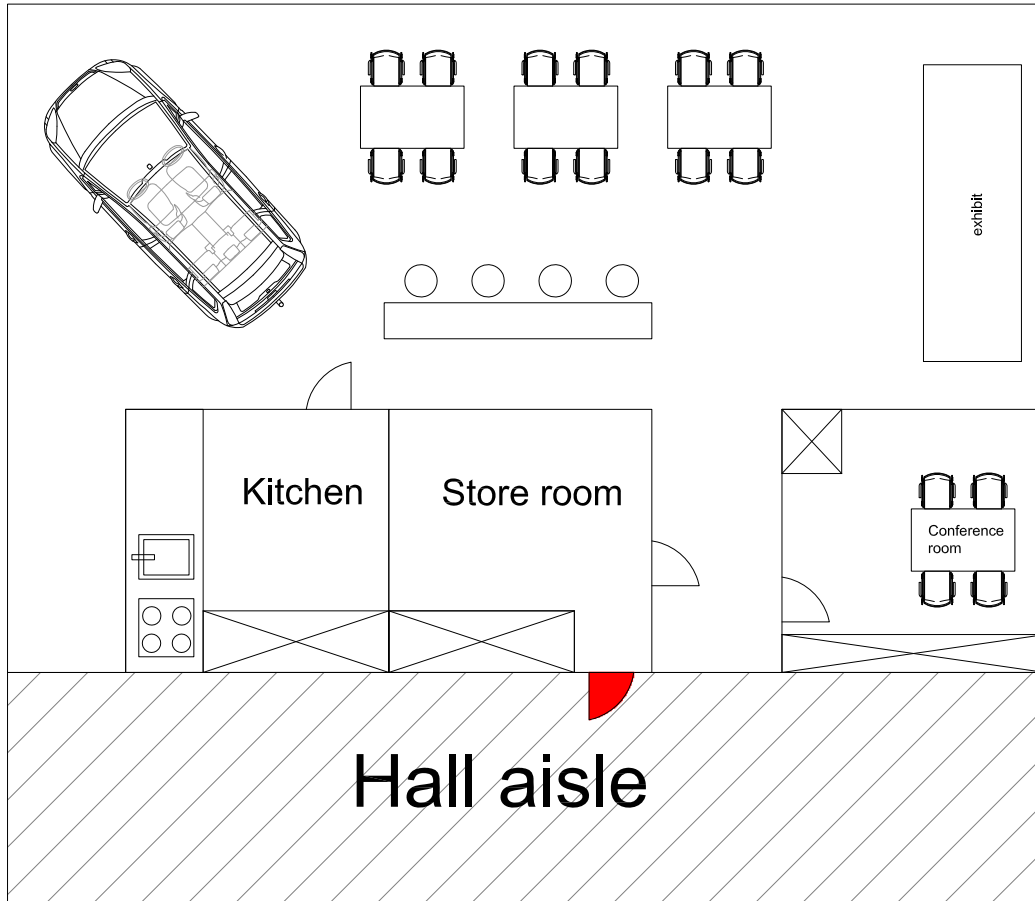

Unauthorized door positioning as the door opens out into a hall aisle.

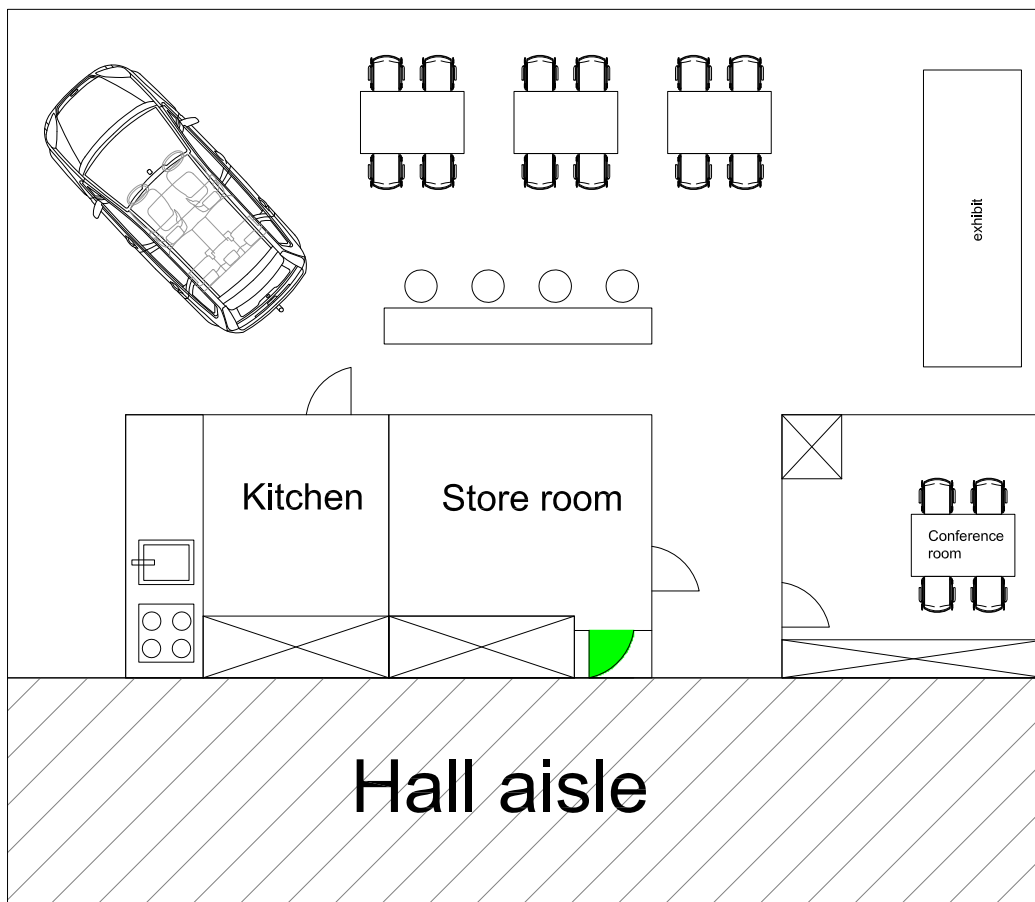



Authorized door positioning as the door does not extend beyond the stand border when opening.

Suitability of fire extinguishers:

A

- Powder
- Foam
- Water





Fires involving solid materials, mainly of an organic nature, which normally form flames and embers on burning

Powder extinguisher with ABC powder Water and foam extinguisher

B

- Powder
- Foam
- CO₂





Fires involving liquids or melting materials

Powder extinguisher with BC and ABC powder Foam extinguisher CO₂ extinguisher

C

- Powder





Fires involving gases (e.g. propane, butane etc.)

Powder extinguisher with BC and ABC powder

D

- Powder

Fires involving metals (e.g. magnesium, aluminum swarf)

Powder extinguisher with D powder

F

- Foam



Fires involving fat and oil, extinguisher marked orange

At least one fire extinguisher conformant with DIN EN 3 with at least 12 extinguishing agent units (EAUs) must be kept on hand during assembly and disassembly and during the event itself at trade fair stands and event spaces larger than 100 m² and in case of electrical distribution boxes with a total power rating of 6 kW.

- The fire classes of fire extinguishers **have nothing** in common with the classification of building products to DIN 4102 and DIN EN 13501.
- The fire classes define **the suitability** of fire extinguishers for fires involving various materials, liquids or vapours that have caught fire.

Extinguishing agent		Fire classes				
Former Code letter		A	B	C	D	F
Water or Aqueous solutions	W		1		2	3
Water mist	W				2	
Foam	S				2	3
BC powder	P					
ABC powder	PG					
Metal fire powder	PM					
Carbon dioxide CO ₂	K				2	
Cooking oil/fat fire extinguisher agent	F		4		2	

● suitable ; ● not suitable

- 1: Risk of fire spreading
- 2: Risk of an explosive reaction
- 3: Risk of an cooking oil /fat explosion
- 4: Suitable for cooking oil/fat extinguishers of class A B F

Example of specified labeling to DIN EN 3:

FEUERLÖSCHER

12 Kg ABC-Pulver
43 A 183 B C



1 Ventil voll aufdrehen



2 Löschpistole betätigen





VORSICHT BEI ELEKTRISCHEN ANLAGEN. NUR BIS 1000 V; MINDESTABSTAND 1m

Nach jeder Betätigung neu füllen!
Löcher längstens alle 2 Jahre auf Einsatzbereitschaft überprüfen. Nur solche Lösch-Treibmittel und Ersatzteile verwenden, die mit dem anerkannten Muster übereinstimmen.

Löschmittel: 12 kg ABC Nr. der Anerkennung: DIN EN 3
 Treibmittel: 280 g CO₂ Typ: G 12 R

Funktionsbereich: -20 °C bis +60 °C

HERSTELLER: _____

Only water extinguishers or foam extinguishers with an up-to-date test seal may be used. Powder extinguishers may only be used for demonstrations with combustible gases. Cleaning costs resulting from the use of powder extinguishers will be charged to the perpetrator.

Generally, all fire extinguishers provided must have been tested by an accredited expert. This must be shown on the fire extinguisher itself by means of a valid test label or tag. All fire extinguishers must be placed in clearly visible and continuously accessible locations in such a way that they cannot topple over and must be labeled in accordance with ASR A1.3.

Preliminary Remarks

The contents of this information sheet are determined by consultation between two German exhibition companies:

Deutsche Messe AG, Hanover
NürnbergMesse GmbH

It forms the basis for the handling and use of explosive mixtures at the exhibition venue, and supplements points 5.2.1 and 5.2.2 of the 2023 Technical Guidelines.

Explosive mixtures

Flammable liquids, gases and dust constitute hazardous materials as defined in § 2 (1) of the German Hazardous Substances Ordinance (Gefahrstoffverordnung, GefStoffV). The handling of such hazardous materials can sometimes result in the formation of dangerous explosive mixtures with the potential to cause personal injury and material and environmental damage.

The requirement to assess the risk of explosion when using materials of this nature is imposed at a European level by Directive 1999/92/EC, and is therefore not restricted to Germany alone. Directives 2006/42/EC (Machinery Directive) and 2014/34/EU (ATEX Directive) establish the fundamental requirement for the manufacturers of plant and machinery to perform a risk assessment in respect of explosion protection. But because exhibitors function not only as manufacturers but also as operators for the purpose of their exhibition activities, they must also observe the provisions of Directive 1999/92/EC. This has been transposed into German law in the form of the Workplace Safety Ordinance (Betriebssicherheitsverordnung) and the Hazardous Substances Ordinance (Gefahrstoffverordnung), which must therefore be applied to exhibition activities as above.

Explosion protection document

On the basis of § 6 (9) of the Hazardous Substances Ordinance, a hazard assessment in respect of explosion protection must be drawn up (i.e. an **explosion protection plan and documentation**). The explosion protection plan is used to determine whether there is a risk of formation, and ignition, of dangerous explosive mixtures, and which protective measures must be put in place accordingly. The method of implementing the protective measures set down in the explosion protection plan is then described in an **explosion protection document in accordance with § 6 (2) of the Hazardous Substances Ordinance**.

If **wood processing machinery** is displayed at the exhibition, and an elevated **build-up of dust or wood chips** can be expected as a consequence, the provisions of German Social Accident Insurance (DGUV) Information Sheets 209-083 and 209-045, on the installation of automatic spark extinguishing systems, must be observed. In justified exceptional circumstances (e.g. if only a limited presentation of the system is given), the requirement to install a spark extinguishing system may be waived subject to written approval by NürnbergMesse (see point 4.2).

It is the responsibility of the exhibitor to draw up the explosion protection document, including confirmation that the required protection measures have been correctly organized and implemented. The following regulations and technical rules may be used as a guide: Hazardous Substances Regulations, Industrial Safety Regulations, TRGS 720 to 725 and TRGS 727. These templates are identical for all exhibitors, to ensure that a uniform and comparable basis for assessment is established. This template is identical for all exhibitors, to ensure that a uniform and comparable basis for assessment is established. Differing assessments are not recommended, since this may increase the time and effort needed for processing and incur additional costs for the exhibitor.

The template of the explosion protection document, completed in full by the exhibitor in either German or English, must be submitted to NürnbergMesse GmbH, together with the necessary accompanying documents, in good time, no later than one month before the start of construction.

Explosion safety check

Based on the documentation made available by the exhibitor, a check of explosion safety is then performed as required by § 15 in conjunction with Annex 2 para 3 no. 4.1 of the Workplace Safety Ordinance. The requirement for the above explosion safety check applies regardless of the size of the plant or the length of time the plant is in operation. The explosion safety check must be performed at a general level, i.e. comprehensively and without exception, before the plant is operated.

It must be noted that the explosion safety check is performed on the basis of the documentation submitted and the plant as constructed. If explosion protection documents are not completed in full or contain errors, if accompanying documents are missing or contain errors, and if any of the Annexes are incomplete, this may seriously impact on the testing process, as a result of which operation of the plant in question will be prohibited.

Because NürnbergMesse GmbH would like to enable all exhibitors to operate their equipment, it urgently recommends that they make the required documentation available in full and observe all deadlines. The sooner the required documents are made available and the equipment is set up, the earlier any defects or inconsistencies can be detected and rectified.

Your attention is expressly drawn to the fact that explosion safety testing is chargeable, and is performed by a third party, not NürnbergMesse GmbH. Additional costs will be incurred if subsequent testing is required as a consequence of failing to observe deadlines or insufficient cooperation on the part of the exhibitor. For reasons of data protection, exhibitors are advised that explosion protection documentation is passed to a service provider tasked with performing the checking process.

The operation of systems posing a risk of explosion in connection with extraction, conveyor, filtering and silo systems must be registered using form P2.1 and requires written approval.

For further information, please contact:

NürnbergMesse GmbH

Exhibition Technology Department
Messezentrum
90471 Nürnberg
eventtechnology@nuernbergmesse.de
www.nuernbergmesse.de

DIE ENTSPRECHENDEN ARBEITSSCHUTZMASSNAHMEN SIND ZU BEACHTEN. SCHLEIFEN UND SÄGEN NUR MIT ABSAUGUNG.

THE RELEVANT OCCUPATIONAL SAFETY MEASURES MUST BE OBSERVED. SANDING AND SAWING ONLY WITH SUCTION.

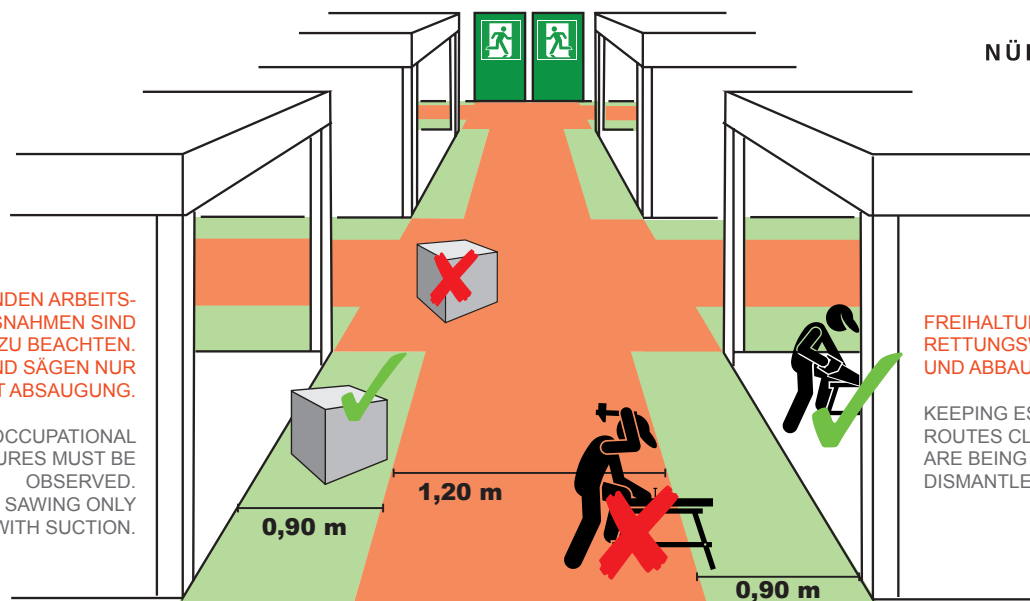

FREIHALTUNG DER FLUCHT- UND RETTUNGSWEGE WÄHREND AUF- UND ABBAUZEITEN.

KEEPING ESCAPE AND RESCUE ROUTES CLEAR WHEN STANDS ARE BEING ASSEMBLED OR DISMANTLED.

STANDAUFBAUARBEITEN STAND CONSTRUCTION WORK

D Es ist aus Sicherheitsgründen unzulässig, die Flucht- und Rettungswege mit Standbaumaterialien zu verstellen. Unabhängig von der Hallengangbreite ist ein Mindestdurchgang von 1,20 m in den Gängen frei zu halten.

Entlang der Standgrenzen zum Hallengang darf daher z. B. bei einer Gangbreite von 3,00 m beidseitig maximal ein Streifen von 0,90 m Breite zum Abstellen von Standbaumaterial genutzt werden.

Die unmittelbaren Flächen vor den Notausgängen und die Kreuzungen der Flucht- und Rettungswege müssen in voller Breite freigehalten werden.

Eine Lagerung von Gütern innerhalb der Flucht- und Rettungswege (siehe Skizze) ist nicht erlaubt.

GB For safety reasons, escape and rescue routes are not allowed to be blocked with stand construction materials.

Regardless of how wide the hall aisles are, each aisle must have a clear path of at least 1.20 m in width all the way down.

This means that in the case of an aisle that is 3.00 m wide, for example, stand construction material can only be rested in a strip of 0.90 m wide on each side along the stand sides bordering the aisle.

The areas directly in front of the emergency exits and the areas where escape and rescue routes cross must be kept completely clear. Goods are not allowed to be stored in escape and rescue routes (see sketch).

E Por motivos de seguridad queda prohibido depositar en las salidas de emergencia y en las vías de rescate materiales de construcción.

Independientemente del ancho de los pasillos del pabellón, debe mantenerse libre un paso mínimo de 1,20 m en los pasillos.

Por lo tanto, a lo largo de los límites del stand con el pasillo del pabellón se puede utilizar, p. ej. con un ancho de pasillo de 3,00 m, máximo a ambos lados una tira de 0,90 m de ancho para depositar material de construcción.

Las zonas inmediatamente situadas frente a las salidas de emergencia y los cruces de las salidas de emergencia y vías de rescate deben mantenerse completamente libres en todo momento.

No está permitido el almacenamiento de mercancías dentro de los límites de las salidas de emergencia y vías de rescate (ver boceto).

I Per motivi di sicurezza è assolutamente vietato lasciare materiale di allestimento lungo le vie di fuga.

Indipendentemente dalla larghezza del padiglione è fatto obbligo di tenere libero un passaggio minimo di 1,20 m lungo i corridoi. Lungo il confine tra il proprio stand e il corridoio del padiglione è quindi possibile, con un corridoio largo ad es. 3,00 m, utilizzare al massimo una striscia di 0,90 m di larghezza su entrambi i lati per depositare il materiale di allestimento dello stand.

Lasciare sempre libere le aree antistanti le uscite d'emergenza e gli incroci delle vie di fuga per tutta la loro larghezza.

È vietato depositare merci all'interno delle vie di fuga (si veda il disegno).

F Pour des raisons de sécurité, il est interdit d'encombrer les voies d'évacuation et de secours de matériaux de construction destinés aux stands.

Indépendamment de la largeur des allées de la halle, il convient de maintenir un passage libre minimum de 1,20 m dans les allées.

Pour une largeur d'allée de p. ex. 3,00 m, un espace d'une largeur maximum de 0,90 m peut être utilisé des deux côtés le long des limites du stand pour déposer le matériel de construction du stand.

Les espaces à proximité immédiate des issues de secours et les intersections des voies d'évacuation et de secours doivent rester dégagés sur toute leur largeur.

Un stockage de marchandises sur les voies d'évacuation et de secours (voir croquis) est interdit.

RUS По соображениям безопасности запрещается загромождать запасные и эвакуационные пути строительными материалами для стендов.

Вне зависимости от ширины проходов павильона необходимо обеспечить свободный минимальный проход 1,20 м. Следовательно, вдоль границ между стендом и павильонным проходом, например, шириной 3,00 м, с обеих сторон для размещения строительных материалов допускается использовать пространство шириной не более 0,90 м.

Зоны непосредственно перед аварийными выходами и перекрестками запасных и эвакуационных путей необходимо полностью освободить.

Запрещается хранить товары в проходах запасных и эвакуационных путей (см. схему).

PL Ze względów bezpieczeństwa niedopuszczalne jest zastawianie dróg ewakuacyjnych i ratowniczych materiałami do budowy stoisk.

Bez względu na szerokość przejść w hali należy zapewnić minimalną szerokość przejścia wynoszącą 1,20 m.

Wzdłuż granic stoisk do przejścia można więc np. przy szerokości przejścia wynoszącej 3,00 m po obu stronach wykorzystać do ustawienia materiału do budowy stoisk pas o szerokości maksymalnej 0,90 m.

Powierzchnie bezpośrednio przed wyjściami ewakuacyjnymi i skrzyżowaniami dróg ewakuacyjnych i ratowniczych muszą być wolne na całej szerokości.

Składowanie towarów na drogach ewakuacyjnych i ratowniczych (patrz szkic) jest niedozwolone.

ROU Din motive de siguranță, este interzisă blocarea căilor de evacuare și de salvare cu materialele de construcție a standului.

Independent de lățimea coridorului halei, trebuie păstrată o distanță liberă de trecere pe coridoare de cel puțin 1,20 m.

Materialele de construcție a standului pot ocupa o lățime de maxim 0,9 m pe ambele părți, de-a lungul perimetrului standului față de coridorul halei, ca de ex., în cazul unui coridor cu o lățime de 3,00 m.

Se vor păstra libere pe toată lățimea lor, zonele din imediata apropiere a ieșirilor de urgență și intersecțiile căilor de evacuare și de salvare.

Nu este permisă depozitarea bunurilor pe căile de evacuare și de salvare (consultați schița).

CZE Z bezpečnostních důvodů je nepřijatelné zahrazovat únikové a záchranné cesty materiálem pro montáž stánku.

Nezávisle na šířce uliček v hale je třeba v uličkách zachovat minimální volný průchod 1,20 m.

Podél hranic stánku směrem k uličce haly smí proto např. při šířce uličky 3,00 m být na obou stranách k odstavení materiálu pro montáž stánku využit maximálně pruh o šířce 0,90 m.

Plochy nacházející se bezprostředně před nouzovými východy a úseky, kde dochází ke křížení únikových a záchranných cest, musí po celé šířce zůstat volné.

Skládování zboží na evakuačních a únikových cestách (viz plánek) není dovoleno.

TUR Güvenlik nedenlerinden dolayı kaçış ve kurtuluş yollarına stand malzemelerinin yerleştirilmesine izin verilmez.

Hal genişliğinden bağımsız olarak geçişlerde en az 1,20 m koridor açık tutulmalıdır. Bu nedenle hal geçişindeki stand sınırları boyunca örn.

3,00 metre genişliğindeki bir koridorda stand malzemelerinin yerleştirilmesi için iki taraflı olarak en fazla 0,90 metre boyutunda bir şerit kullanılabilir.

Acil çıkışların hemen önündeki alanlar, ayrıca kaçış ve kurtuluş yollarının birleştiği yerler olduğu gibi açık tutulmalıdır.

Kaçış ve kurtuluş yolları dahilinde malların depolanmasına izin verilmez (taslağa bakınız).

Information Sheet

“Glass in stand construction inside trade fair halls” 2023

PRELIMINARY REMARK

The contents of this information sheet have been jointly agreed upon by the following German exhibition companies:

Deutsche Messe AG Hannover
 KölnMesse GmbH
 Landesmesse Stuttgart GmbH
 Leipziger Messe GmbH
 Messe Berlin GmbH
 Messe Düsseldorf GmbH
 Messe Frankfurt Venue GmbH
 Messe München GmbH
 NürnbergMesse GmbH

It offers structural and design notes to Chapter 4.4.3 of the Technical Guidelines and defines the design specifications and requirements for the glass constructions in stand and decorative structures to be built within the trade fair halls of NürnbergMesse.

In the absence of additional specifications in this document, the Technical Guidelines (TR) of NürnbergMesse apply.

TABLE OF CONTENTS

1.	SCOPE
2.	DEFINITIONS AND EXPLANATIONS
2.1	Types of supports
2.2	Types of glass and other transparent plastics
2.3	Design calculation standards
2.4	Material properties of glass products
3.	STAND DESIGN, CONSTRUCTION AND LOADS
3.1	Vertical glazing not intended to prevent falling
3.1.1	Vertical glazing with a height $h \leq 4$ metres above hall floor level
3.1.2	Vertical glazing of height $h > 4$ metres above hall floor level
3.2	Vertical glazing intended to prevent falls
3.2.1	Category A: Vertical glass wall
3.2.2	Category B: Clamped glass balustrade with continuous handrail
3.2.3	Category C: Railing and balustrade infills or glass walls with load-distributing cross-bar fitted in front of it
3.3	Horizontal glazing
3.3.1	Overhead glazing
3.3.2	Glazing designed to support human loads
4.	APPROVAL PROCEDURES
4.1	Basics
4.2	Installation approval for a specific case
5.	NOTES ON DESIGN AND DESIGN CALCULATIONS
6.	EXAMPLES OF VERTICAL GLAZING IN STRUCTURES DESIGNED TO PREVENT FALLS
6.1	Category B
6.2	Category C 1 (railing infills)
6.2.1	Railing infills secured vertically on 2 sides
6.2.2	Railing infills secured horizontally on 2 edges
6.2.3	Railing infills secured on 4 sides
6.2.4	Point-fixed with drilled anchors (design specifications according to DIN 18008-4)
6.2.5	Railing infills with point mounting, lateral clamps and anti-slip grips
6.2.6	Railing infills with point mounting and clamps at top and bottom
6.3	Balustrade with fixed horizontal bars (protection against falling is provided solely by sufficiently strong handrails and knee-height bars)
7.	CONSTRUCTION ENGINEERING REGULATIONS, GENERALLY ACCEPTED RULES OF ENGINEERING AND REFERENCES
8.	ABBREVIATIONS
9.	SPREADSHEETS A – D (FOR STAND CONSTRUCTION)

“Glass in stand construction inside trade fair halls” 2023 (continued)

1. Scope

Information sheet discusses the regulations concerning the use of glass in stand construction and design **inside the trade fair halls** NürnbergMesse. It does not apply to stand construction and design outside trade fair halls. Designing, dimension calculations and assembly of glass components for use inside trade fair halls require that the design, planning and assembly personnel involved is adequately qualified for glass construction projects. Glass structures which have received general construction approval (including European Technical Approval ETA) may be used in all cases in trade fair halls in accordance with the wording of the approval. This information sheet does not imp

2. Definitions and explanations

2.1 Types of supports

- Glazing secured by linear supports: Secured by linear supports on at least two opposite edges over the full length of each edge of the glass plate.
- Glazing secured at individual points: Glazing anchored through drilled holes or by a clamping system.

2.2 Types of glass and other transparent plastics

Types of glass granted statutory construction approval:

- **Float glass** (polished plate glass, SPG) as specified in DIN EN 572-9: Also called plate glass. It is characterised by relatively low ultimate flexural strength, and when destroyed, it fragments into large sharp-edged shards. **Its use as single sheet glazing in trade fair construction is prohibited.** If used in LSG, it is permitted in trade-fair construction.
- **Tempered safety glass (TSG)** as specified in DIN EN 12150-2: TSG is a fully thermally pre-stressed type of glass. It has internal residual stress characteristics: core tensile stress and surface compression stress. It has high ultimate flexural strength and when broken, it shatters into crumb-like fragments. Where TSG is referred to in this information sheet, TSG made of float glass is always meant.

- **Laminated safety glass (LSG):** LSG consists of at least two sheets of PPG, TSG or HSG glass. The individual thicknesses of these are not permitted to differ from each other by a factor of more than 1.5. The sheets of glass are laminated together by intermediate film layers (PVB or SGP films). If a sheet is broken, then the film prevents the fragments from being scattered, thus providing residual load-bearing capacities and reducing the risk of injury from cuts.

- **Heat-strengthened glass (HSG)** as specified in DIN EN 1863-2 or with other general approvals by building authorities (German: *allgemeine bauaufsichtliche Zulassung – abZ*): TVG is a type of glass that is only partially thermally pre-stressed. Its ultimate flexural strength is lower than that of TSG (tempered safety glass). When broken, HSG fragments into shards which are larger than those of broken TSG. Therefore LSG sheets made of HSG have higher residual load-bearing capacities than LSG sheets made of TSG. HSG laminated with PVB film is included in Building Regulation List A. A general construction approval by building authorities (German *allgemeine bauaufsichtliche Zulassung – abZ*) for the SGP film is required for HSG laminated with SGP.

Not permitted, on the other hand, are transparent panels made of mostly thermoplastic plastics for which no recognized engineering rules or certificates of usability in buildings or structural installations are available. Examples:

- **Acrylic glass** (PMMA), sold under the brand names *Plexiglas®* or *Perspex®*, for example;
- **Polycarbonate** (PC), sold under the brand name *Makrolon®*, for example;
- **Polyethylene terephthalate glycol** (PET-G).

These materials may only be used for non-supporting, non-bracing components that are not intended to prevent falling, thus for decorative or ornamental applications, for example.

In this case, however, due consideration must be given to the **critical smoking and burning behaviour** (e.g. normally flammable, strong smoke development) of these materials. In particular, the decorative use of such materials above persons is impermissible due to the frequently proven (burning) dripping behaviour in case of fire.

2.3 Design calculation standards

The static strength proof calculations for glass components must be carried out in accordance with the following design calculation concept and structural design standards (as amended): Glass in building design and construction rules.

DIN 18008 (T.1 - T.5) – Glass in building design and construction rules

- Part 1: *Terms and general bases*
- Part 2: *Linearly supported glazing*
- Part 3: *Point-fixed glazing*
- Part 4: *Additional requirements for barrier glazing*
- Part 5: *Additional requirements for walk-on glazing*

Table 1: Design concept

Design concept
Proof concept
Determination of action effects and stresses
Deformation checks
Designation of forces/stresses in the serviceability limit state SLS (forces due to characteristic loads, without γ_f)
Designation of forces/stresses in the ultimate limit state (ULS) (forces due to characteristic loads, multiplied by γ_f)
Designation of the limit stress
Dimension calculation rules, dimension calculation standards
Standards applying to loads and actions
Normal load factors γ_f for permanent loads (e.g. dead loads)
Normal load factors for variable loads and actions (e.g. dynamic pressure, imposed loads, cross-bar pressures)
Duration of loads typically encountered at trade fairs for k_{mod} from DIN 18008-1, Table 6

Load factor concept
$\sigma_k \cdot \gamma_f < f_k \cdot k_c \cdot k_{mod} / \gamma_M$
At ULS (GZT)
At SLS (GZG)
SLS (GZG) after the number or index k after formula symbol e.g. supporting force = 12 kN (SLS) or $F_k = 12 \text{ Kn}$
ULS (GZT) after the number or index d after formula symbol e.g. supporting force = 16 kN (ULS) or $F_d = 16 \text{ kN}$
f_k
DIN 18008-1 [12]
DIN 18008-2 [13]
DIN 18008-3 [14]
DIN 18008-4 [15]
DIN 18008-5 [16]
This information sheet and DIN EN 1991-1-1 DIN EN 1991-1-1/NA: (2010-12)
1.35
1.5
Own weight: permanent ($k_{mod} = 0.25$)
Working loads: medium ($k_{mod} = 0.4$)
Horizontal substitute load: short ($k_{mod} = 0.7$)
Cross-bar pressure: short ($k_{mod} = 0.7$)

Information Sheet

“Glass in stand construction inside trade fair halls” 2023 (continued)

Based on the above-mentioned standards and design calculation concept, verifiable static load calculations must be performed for **all** glass constructions and they must be built in conformance with the applicable standards, depending on the planned use as

- Vertical glazing, including (where applicable) **the function of preventing falls** in the case of balustrades
- Overhead glazing,
- Walk-on glazing.

For static load calculations, the load factor concept shall be used as a basis. Supporting forces transmitted by glass components must always be stated for the GZT (ULS) so that the loads of the connected force-transmitting components of concrete, steel or wood can be calculated using the load-factor concept without transmission errors.

Note on the use of wire glass:

In consultation with the trade fair company, wire glass can still be used in existing components with certifications, based on the design calculation standards in effect at the time of initial construction of the trade fair stand.

2.4 Material properties of glass products

Glass products have a bulk density of 25 kN/m³, a thermal expansion coefficient of 8.4·10⁻⁶/K and their Young’s modulus is 70.000 N/mm².

For structural design calculations, the design calculation values of the resistance R_d listed in *Table 1* must be observed.

Table 2: Normal material properties for design calculation concept B, application of load factors

Property	Float glass (not printed, not sand-blasted)	HSG (not printed, not sand-blasted)	HSG (printed/ enamel-coated)	ESG (not printed, not sand-blasted)	ESG (printed/ enamel-coated)
Normal limit stress f_k as DIN EN 572-1, DIN EN 1863-1 or abZ, DIN EN 12150-1	45 N/mm ²	70 N/mm ²	45 N/mm ²	120 N/mm ²	90 N/mm ²
Design coefficient k _c , normal	1.8	1	1	1	1
k _{vSG} for laminated safety glass	1.1	1.1	1.1	1.1	1.1
k _{kante} for calculating the effect of glass edges	0.8	1	1	1	1
Material factor γ _M	1.8	1.5	1.5	1.5	1.5
Modification factor for calculating the effect of load durations k _{mod}	permanent: 0.25 medium duration: 0.4 short: 0.7				
Rated value of the resistance to stress failure R_d	$R_d = k_{mod} * k_c * k_{vSG} * k_{kante} * f_k / \gamma_M$	$R_d = k_c * k_{vSG} * k_{kante} * f_k / \gamma_M$	$R_d = k_c * k_{vSG} * k_{kante} * f_k / \gamma_M$	$R_d = k_c * k_{vSG} * k_{kante} * f_k / \gamma_M$	$R_d = k_c * k_{vSG} * k_{kante} * f_k / \gamma_M$

The intermediate films in LSG shall be made of PVB (polyvinyl butyral) or SGP (*Sentry glass plus/ionoplast*):

- Films made of PVB must have a tear strength of at least 20 N/mm².

- Films or laminated safety glass made of SGP shall have general approval by building authorities (including European Technical Approval ETA) and shall be processed in accordance with this approval.

3. Stand design, construction and loads

3.1 Vertical glazing not intended to prevent falling

3.1.1 Vertical glazing with a height h ≤ 4 metres above hall floor level

Neither static proof of structural characteristics in accordance with the regulations specified in Chapter 2.3 is required, nor is it necessary to submit documentation of testing. In this case the exhibitor alone is responsible for ensuring that the construction/design is technically safe for general use and that it meets current and accepted technical standards. Table A provides an overview of the types of structural designs that are possible.

- Either TSG or LSG must be used.
- The glass sheets may be secured by linear supports or at individual points.
- **Glass walls tilting at an angle of more than 10° from the vertical are considered to be overhead glazing** for which the provisions of Chapter 3.3 shall apply.
- Additional measures, e.g. provision of static proof calculations similar to those described in chapter 3.1.2, may be required to ensure protection of neighbouring walkways, or to be able to bear the loads of persons leaning against or bumping into the glass.

3.1.2 Vertical glazing of height h > 4 metres above hall floor level

Vertical glazing **not** intended to prevent falling and whose uppermost edges are higher than 4 metres above hall floor level does **not** require **Installation approval for a specific case** (c.f. 4.2) provided that the type of glass used, structural design details and the type of supports securing the glass comply with the regulations specified in Chapter 2.3.

In addition, the following provisions shall be observed:

- Verified structural calculations or structural calculations suitable for verification and the corresponding construction plans must be submitted.
- In addition to the load of its own weight, the material must be capable of resisting horizontal forces, i.e. a pressure corresponding to at least h1 = 0.125 kN/m² for visible surfaces of up to 4 m above hall floor level and at least h2 = 0.063 kN/m² for visible surfaces at more than 4 m above hall floor level.
- Wherever there is a high risk of impact, e.g. where there is a descending ramp leading towards the glazing, additional measures are required.
- Proof of structural characteristics is not required if the area of each individual sheet is less than 1.6 m² and TSG with a thickness of at least 4 mm is used, and the sheet(s) is(are) held on four sides by linear supports.
- Glazing secured at individual points may be used without further proof documentation if:

- general construction approval (*abZ*) has already been granted for the combination of point-mounting method and glass type and thickness, or
- the design specifications, and the dimensions and thickness of the glass as stated in DIN 18008-3, DIN 18008-4 or Table B are adhered to.

DIN 18008-3/-4 and Table B are referred to above because the fall-prevention glazing barriers described in these references are of course also suitable for glass panels not explicitly intended to prevent falls.

Installation approval for a specific case is required for all other designs.

If the use of TSG glazing is planned, a heat soak test certificate as TSG-H. Table A provides an overview of possible designs and the necessary proofs.

3.2 Vertical glazing intended to prevent falls

In all three of the following **categories, A, B and C**, static load proof calculations for the glass and the supporting structures and proof of the load-bearing capacity under impact-like conditions are required.

The static structural design calculations for the glass and the supporting structure shall be based on an assumed cross-bar pressure load and as an additional load case, a horizontal assumed surface load of h1 = 0.125 kN/m² for all visible surfaces at up to 4 m above the hall floor level and of h2 = 0.063 kN/m² for surfaces located at more than 4 m above hall floor level.

The load-bearing capacity of the structure under impact action can be verified as follows:

- a pendulum impact test in accordance with DIN 18008-4
- the relevant design specifications, glass dimensions and thicknesses as stated in Table B of this information sheet are adhered to, or
- by providing proof calculations in accordance with the rules described in Chapter 2.3.

Table B contains an overview of possible designs and the proofs required. All structural design details (including flexing/sag and glass insertion/clamping depths) shall be modelled in accordance with the rules described in Chapter 2.3.

Experimental pendulum impact tests must be carried out by one of the test centres/institutes named in Chapter 4 well in advance of the fair and outside the trade fair halls.

“Glass in stand construction inside trade fair halls” 2023 (continued)

3.2.1 Category A: Vertical glass wall

Definition: Linearly-supported vertical glazing that does not contain any load-bearing bars at capping height and is not protected by a rail or cross-bar located in front of it, making it suitable for the direct action of rail or cross-bar loads, e.g. glazing of full room height.

If protection is required to prevent persons falling from a height of more than 0.2 then it will be necessary to refer to the Technical Regulations for accident-prevention (barrier) glazing or DIN 18008-4.

- Only LSG shall be used.
- Verified proof of structural characteristics or static structural calculations suitable for verification, as well as a pendulum impact test (test in accordance with DIN EN 12 600 or DIN 18008-4) are required.
- The pendulum impact test is not required for glass with linear support on all sides, provided that the appropriate dimensions and glass thickness conform to Table B, DIN 18008-3 and DIN 18008-4, or proof calculations are carried out in accordance with DIN 18008-4.
- The glazing supports must provide adequate protection to the edges of the glass sheets.

3.2.2 Category B: Clamped glass balustrade with continuous handrail

Definition: Load-bearing glass balustrades held by linear supports secured by clamp-type base mountings, the individual glazing elements of which are connected by a continuous, load-bearing handrail (see example in Chapter 6.1) attached to the top of the structure.

- Only LSG shall be used.
- Verified proof of structural characteristics or static structural calculations suitable for verification, as well as a pendulum impact test (test in accordance with DIN 18008-4) are required.
- If LSG made of 2 x 10 mm TSG (or 2 x 10 mm HSG) is used, no pendulum impact test is required, provided that the dimensions as stated in Table B are adhered to (design details in accordance with DIN 18008-4).
- The thickness of the intermediate PVB/SGP film must be at least 1.52 mm.
- The securing clamps/ clamping must be at least 100 mm above floor level.

Calculations shall be provided proving that the loads will be distributed via the capping to neighbouring glass sheets in the event of an individual sheet being destroyed. The stresses occurring in the neighbouring glass sheets can be classified as an extraordinary design calculation situation. The destroyed or damaged glass sheet shall be replaced immediately after the incident.

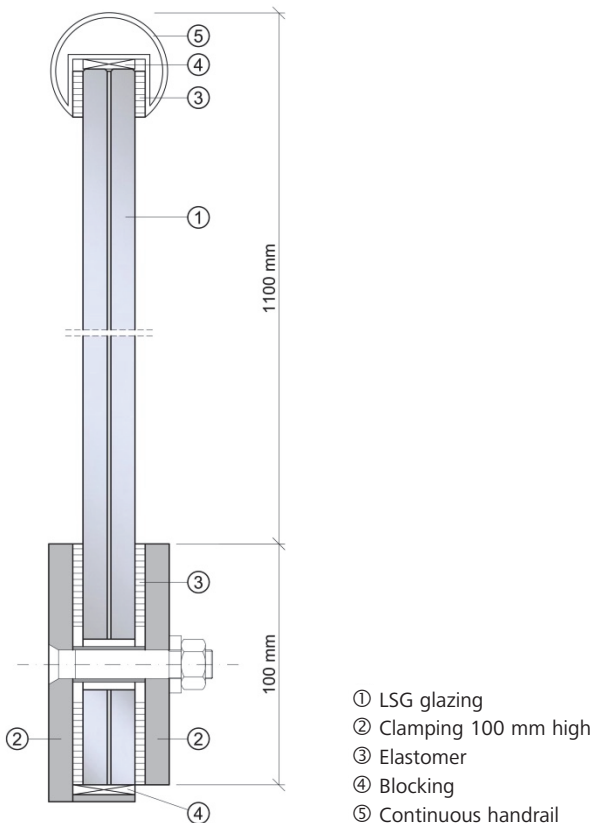
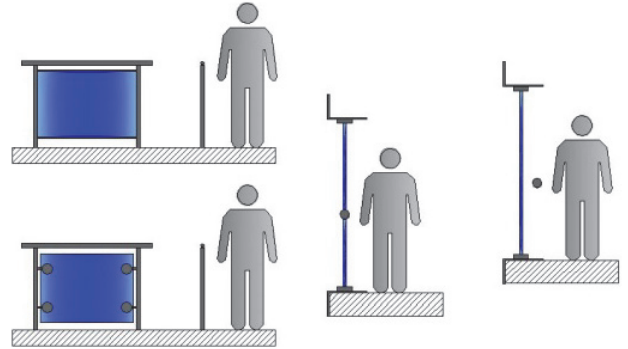

Figure 1: Clamped glazing with continuous handrail

3.2.3 Category C: Railing and balustrade infills or glass walls with load-distributing cross-bar fitted in front of it

Definition: Accident-prevention (barrier) glazing which is not intended to distribute capping loads and which corresponds to one of the following groups:

- C1: Railing/balustrade infills secured by linear supports and/or at individual points on at least two opposing sides.
- C2: Vertical glazing beneath a crosswise load-distributing spanning member located at capping level and secured by linear supports on at least two opposing sides.
- C3: Category A type glazing with a load-distributing handrail placed in front of it.



Category C1

Category C2

Category C3

- For Category C1 and C2 type glazing, the use of TSG is allowed if the sheets are secured by linear supports on all sides. For all other types of supports and for Category C3, only LSG may be used unless other statutory construction approval exists.
- Table B contains an overview of possible designs and the proofs required.
- The pendulum impact test is not required if the relevant design specifications and the dimensions and thickness of the glass as stated in Table B or in DIN 18008-4 are adhered to.

Alternative measures/protection against glass breakage:

If the proof calculations for Category C in accordance DIN 18008-4 are not submitted for accident-prevention (barrier) glazing, then the accident-prevention (barrier) attribute can be achieved by installing adequately sturdy knee-height cross-bars or tightly stretched steel rope of at least 5 mm diameter at a vertical spacing of not more than 35 cm and at an adequate distance in front of the glass sheets of the balustrade infill. Measures to protect against scattering glass splinters shall always be installed above and along the length of traffic areas (walkways), if this is not possible, LSG shall be used.

3.3 Horizontal glazing

3.3.1 Overhead glazing

Glass walls tilted at an angle of more than 10° from the vertical are considered to be overhead glazing. Table C contains an overview of possible designs and the proof documentation required.

Only the following glass products may be used:

- LSG made with float glass (PPG)
- LSG made of HSG,
- Wire glass (only for existing components until effective span exceeding 0.7 m and the glass shall protrude into the supports by at least 15 mm).

In addition to submitting certification of load-bearing capacities, experimental of residual load-bearing capacities must be provided or, if this is not possible, a safety net must be hung under the glazing. If the structural design requirements of specified in DIN 18008-2 are met, proof of the residual load-bearing capacities is not required. The design loads to be assumed are the sheet's own weight and a horizontal pressure corresponding to at least $h_1 = 0.125 \text{ kN/m}^2$ for visible surfaces of up to 4 m above hall floor level or $h_2 = 0.063 \text{ kN/m}^2$ for vertical visible surfaces at more than 4 m above hall floor level. The sheets must be secured in such a way as to properly safeguard against them slipping out of the mounts and forces which may lift them off the mounts.

The design dimensions of glass sheets mounted at individual points and HSG sheets shall either be calculated according to the rules outlined in chapter 2.3 or they must have general construction approval (*abZ*).

Information Sheet

“Glass in stand construction inside trade fair halls” 2023 (continued)

If, for cleaning purposes, overhead glazing periodically has to support human loads, then such additional loads must be taken into consideration and experimental proof of residual load-bearing capacities must be provided [16]. In such cases, a special individual construction approval is always required.

Other design standards for overhead glazing:

- LSG sheets with an effective span exceeding more than 1.20 m shall be supported on all sides.
- The overall thickness of the intermediate PVB-/SGP-films must be at least 0.76 mm. If a sheet is supported on all sides, then a thickness of 0.38 mm is allowed under the condition that the effective span in the direction bearing the main load is not greater than 0.8 m.
- Cutting of recesses or notches in the glass sheets is not allowed.
- Only holes conforming to DIN 18008-3 are allowed.
- The maximum permissible sag shall not exceed 1/100 of the effective span between the closer supports of the sheet.

3.3.2 Glazing designed to support human loads

This kind of glazing is specifically intended to be subjected to persons walking over it, e.g. stairs, platforms, landings and cat-walks. The design and proof calculations shall take both dead loads (own weight) and the working loads into account. In addition, proof of impact resistance and residual load-bearing capacity shall be provided.

Proof of impact resistance and residual load-bearing capacities must be demonstrated by component tests or a general construction approval (abZ). The requirements are specified in DIN 18008-5 [16]. For glazing mounted in linear supports at all four edges and an assumed working load of not more than 5.0 kN/m² for design calculations (as specified in DIN EN 1991-1-1/NA - Cat. C3/T2), proof of impact resistance and residual load-bearing capacity is deemed to have been provided if the sheets conform to the dimensions listed in Table 3.

Table 3: Glazing mounted in linear supports at all four edges and intended to support human loads, with proven impact resistance and residual load-bearing capacity

max. length [mm]	max. width [mm]	LSG structure [mm] (top /*/ centre /*/ bottom)	Min. supporting surface depth [mm]
1500	400	8 HSG /*/ 10 Float /*/ 10 Float	30
1500	750	8 HSG /*/ 12 Float /*/ 12 Float	30
1250	1250	8 HSG /*/ 10 HSG /*/ 10 HSG	35
1500	1500	8 HSG /*/ 12 HSG /*/ 12 HSG	35
2000	1400	8 HSG /*/ 15 Float /*/ 15 Float	35

/*/ = 1.52 mm PVB – PVB or SGP (SentryGlas® plus)

Glazing designed to support human loads may be secured by linear supports or at individual points. It must be made of **LSG consisting of at least three layers** of TSG and/or HSG/float glass. From the point of view of impact resistance, the use of TSG or HSG for the top layer is recommended. This surface must possess non-slip characteristics in accordance with DIN 51097. In order to achieve the required residual load-bearing capacity, the two lower layers will normally be made of float glass or HSG.

Glazing, mountings and supporting structure must be designed and their dimensions calculated to withstand the load of their own combined weight (dead load) as well as intended human (working) loads in accordance with the applicable standards.

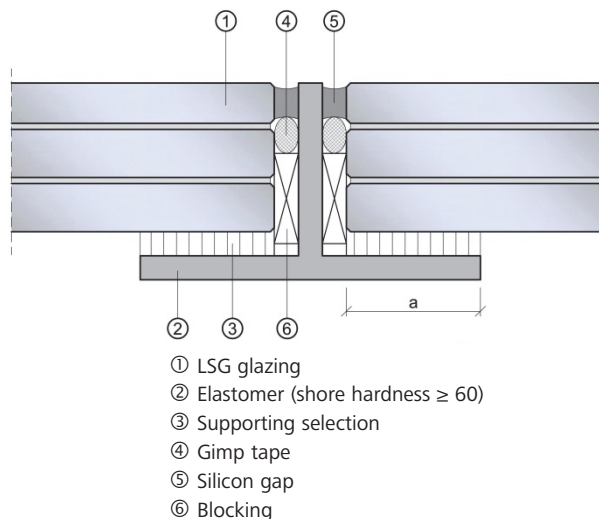

Figure 2: Supporting surface depth a (glass insertion depth)

Table 4: Measurement parameters for walk-on glass

Design calculation concept	DIN 18008-5
Working surface load q_k , depending on usage category as specified in DIN EN 1991-1-1 or DIN EN 1991-1-1/NA	C1: 3.0 kN/m ² C3, T2: 5.0 kN/m ²
Point load Q_k as an additional changing load parameter to be investigated	C1: 4.0 kN C3: 4.0 kN / T2: 2.0 kN
Application area of point load	50 x 50 mm
Inclusion of top sheet in structural static calculations allowed	For constant design situation and for temporary design situation
Proof calculation for situation with broken top sheet (i.e. only the two lower sheets still bear the load)	Proof for an extraordinary design load calculation situation
Standards relating to the action of loads	DIN EN 1991-1-1 DIN EN 1991-1-1 /NA
Max. sag/flexure f_{max} with 3 load-bearing sheets	l/200
Max. sag/flexure f_{max} with 2 load-bearing sheets	l/100

In the case of **stairways**, the construction/design must guarantee sufficient distribution of loads. Stairs on stand structures in the trade fair halls shall always be classified with **usage category T2**.

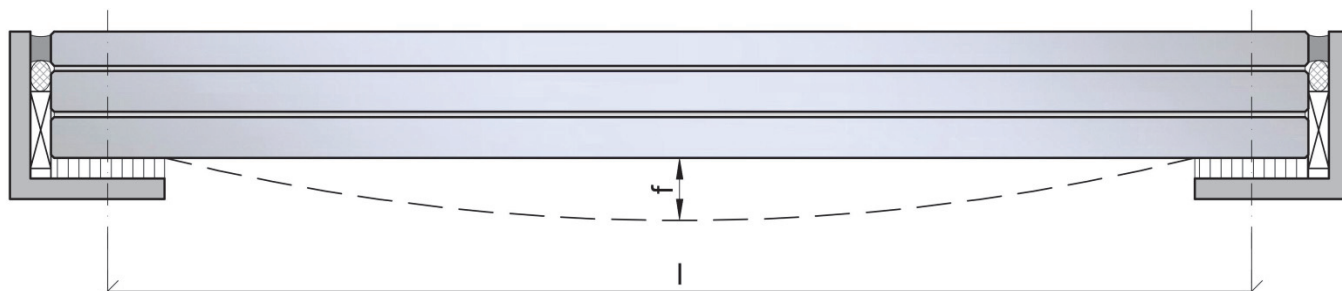

Figure 3: Span and sag

“Glass in stand construction inside trade fair halls” 2023 (continued)

4. Approval procedures

4.1 Basics

If a glass component and its glass products conform to the technical building regulations outlined in Chapter 2.3 and to generally accepted technical principles, then it shall be sufficient to submit the verified or verifiable structural calculations and plans. After that, the verification will be performed and if the documents are verified, construction approval will be granted. In addition, the construction work on site will be checked and the results subjected to an approval inspection.

If additional components are installed for which statutory construction approval (abZ), a statutory construction test report (abP) or type approval are required, then these documents are to be submitted together with the structural calculations.

If a glass component or parts of this component do not conform to the construction engineering regulations and generally accepted technical principles outlined in chapter 2.3, and if no statutory construction approval or statutory construction test certificate can be produced, then an *individual construction approval (Zustimmung im Einzelfall – ZIE)* shall be required. An Installation Approval for a Specific Case may be granted by NürnbergMesse instead of the individual construction approval if glass is used only within the rules and limitations described in this information sheet.

4.2 Installation approval for a specific case

This approval procedure is similar to the procedure for obtaining an *individual construction approval*.

If an **Installation Approval for a Specific Case** has been granted once for a particular construction/design and type of usage, then the German trade fair companies in question will accept this for an identical design serving an identical purpose.

Nevertheless, a new application for construction work approval and approval inspection shall be submitted for each repeated case. The test report, all certificates and approvals, design details, as well as glass dimensions and thicknesses must be submitted with the application.

Glass components requiring approval and which require type 3 proof documentation are listed in column 14 of the Spreadsheets A, B and C. Installation approvals for specific cases cannot be granted at short notice, as they require a considerable period of time for processing. Applications for these should therefore be submitted at least **42 days before the commencement of construction**.

Prior to conducting component tests, it is advisable to contact NürnbergMesse in good time in order to coordinate procedures and intended testing methods. Normally, component testing requirements stipulate inclusion of parts of the glass component’s actual substructure in order to simulate realistic loads.

The procedure for obtaining an **Installation Approval for a Specific Case** from NürnbergMesse is as follows:

- The structural calculations and the required certificates confirming the identity of the product(s) (glass manufacturer/processing company’s factory certificates) must be verified and checked by a publicly certified structural building surveyor and tester (in the field of steel, concrete and brick construction/engineering).
- The surveyor shall confirm that there are no objections with regard to the design’s suitability for use. It is his responsibility to decide on the necessity of additional testing of materials, impact resistance and whether further proof of residual load-bearing capacities must be obtained. The test report must be submitted to NürnbergMesse (Exhibition Technology Department, see Technical Regulations Chapter 4.2) along with the other application documents requesting the construction permit.
- Final approval will be granted on location following an inspection to confirm that the construction/design on site conforms to the previously inspected documents. **The test engineer carrying out the monitoring and inspection acts on behalf of NürnbergMesse and at the expense of the requesting exhibitor/customer.**

Recommended institutes for testing components used in glass construction/design are listed in **Table D**.

5. Notes on design and design calculations

Glass is a brittle material, any failure of which will occur spontaneously and without warning. Glass is sensitive to blows with hard, pointed objects.

These properties lead to the following guideline notes:

- Proof calculations for the load-bearing capacity of structural glass not only take into consideration the unbroken glass but always include an investigation of the broken or partially broken glass (proof of **residual load-bearing capacity**)
- The support design must ensure that glass sheets are **not subjected to pressure or stresses by the supports**.
- Direct glass-to-glass contact and contact between glass and other hard materials (e.g. metal) shall be prevented at all times, whereby the effects of load and temperature fluctuations have to be taken into account.
- The minimum supporting depths of glass sheets (“glass insertion depth”) on their respective support sections as well as the allowable sheet and supporting beam sections as specified in Chapter 2.3 for the design calculation concept must be adhered to.
- After glazing has been installed, the markings identifying the individual type of glass sheet used (e.g. TSG, HSG) must be durable and legible at all times. In the case of LSG glazing, a section of the edge must be left free for inspection purposes (to check the number of glass sheets, thickness, interlayer films) until the construction has been approved. If required, a manufacturer’s certificate shall be submitted as well.
- The edges of glass sheets must be finished or protected in such a way as to exclude any possibility of injury.
- In the case of TSG, HSG, or LSG glazing manufactured from sheets of TSG or HSG, subsequent reworking of the finished product such as cutting out sections or drilling holes is not possible.
- Sheets intended to bear human loads must have a durable non-slip surface finish.
- Load-bearing adhesive joints may only be used if a general construction approval (*abZ*) has been granted for the entire adhesive system (i.e. the glass, adhesive and metal combination), and under the condition that the joint is made exactly as described in the approval documents. The rules described in Chapter 2.3 do not yet make allowance for applying more favourable assumptions of the joint effect of the intermediate film layers in LSG and therefore an **Installation Approval for the Specific Case** has to be applied for if these assumptions are used in calculations. Trade publications [18] contain information on suitable calculation assumptions to account for the joint effects in LSG. This may possibly be useful for LSG in which SGP is used.

6. Examples of vertical glazing in structures designed to prevent falls

All possible dimensions, types of glass, thicknesses and the necessary proof documents are summarised in Table B

6.1 Category B

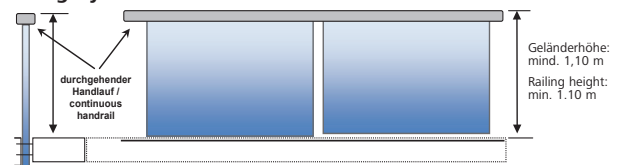

Note:

If LSG made of
 - 10 mm TSG + 1.52 mm PVB/SGP + 10 mm TSG, or
 - 10 mm HSG + 1.52 mm PVB/SGP + 10 mm HSG
 in the dimensions as stated in Table B is used, only static structural proof calculations are required.
 As specified in DIN 18008-4, this also applies to parallelogram-shaped balustrades.

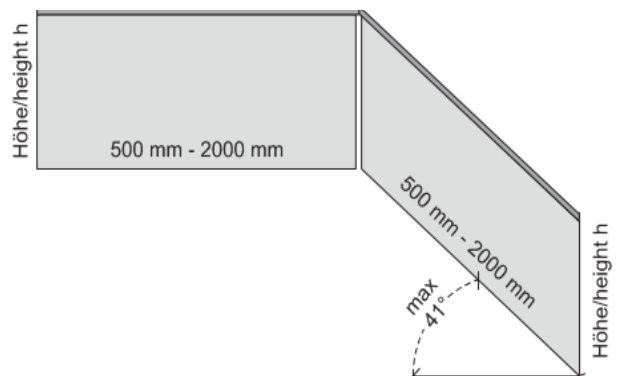

Information Sheet

“Glass in stand construction inside trade fair halls” 2023 (continued)

6.2 Category C 1 (railing infills)

6.2.1 Railing infills secured vertically on 2 sides

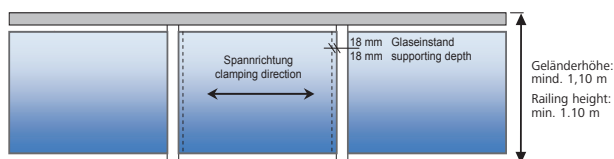

Note: If the types of glass and the dimensions listed in Table B are used, only static structural proof calculations are required.

6.2.2 Railing infills secured horizontally on 2 edges

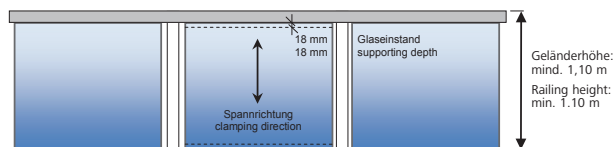

Note: If the types of glass and the dimensions listed in Table B are used, only static structural proof calculations are required.

6.2.3 Railing infills secured on 4 sides

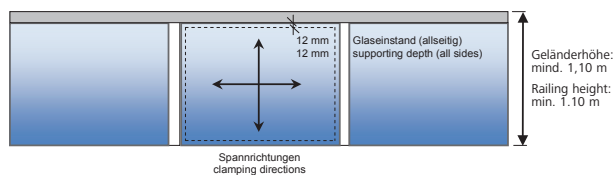

Note: If the types of glass and the dimensions listed in Table B are used, only static structural proof calculations are required.

6.2.4 Point-fixed with drilled anchors (design specifications according to DIN 18008-4)

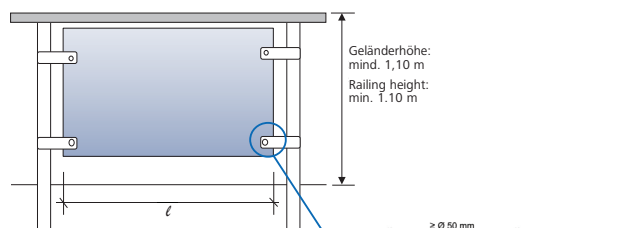

Note: If the types of glass and the dimensions listed in Table B are used, only static structural proof calculations are required for all point-fixed variants sided or 4-sided).

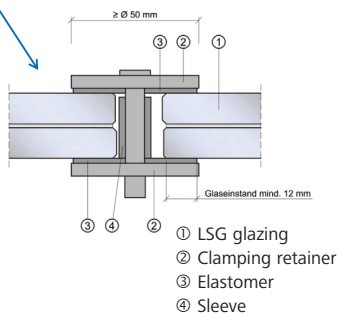
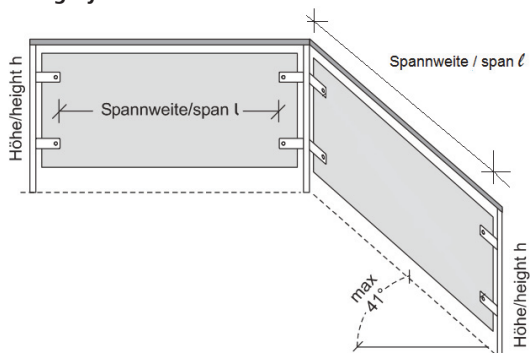

Figure 4: Cross-section of clamping plate holder

In accordance with DIN 18008-4, the rules for Categories C1 and C2 also apply to parallelogram-shaped balustrades:

Category C1



Category C2

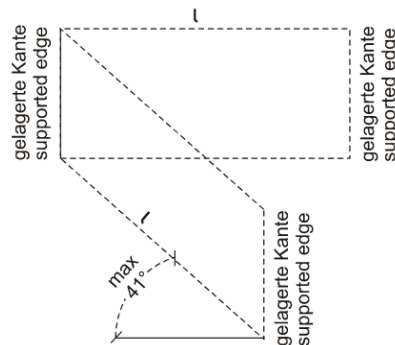

6.2.5 Railing infills with point mounting, lateral clamps and anti-slip grips

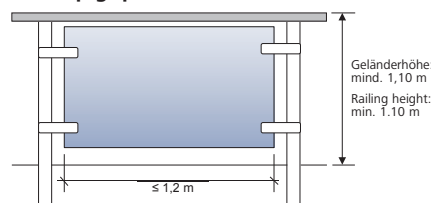

Note: Designs that have a general construction approval (abZ) shall be used in accordance with the specifications in the approval documents.

For all systems that have not been granted general construction approval, a pendulum impact test is required. Minimum requirement: **LSG** comprising :
 - 6 mm TSG + 1.52 mm PVB + 6 mm HSG or
 - 6 mm HSG + 1.52 mm PVB + 6 mm HSG shall be used.

6.2.6 Railing infills with point mounting and clamps at top and bottom

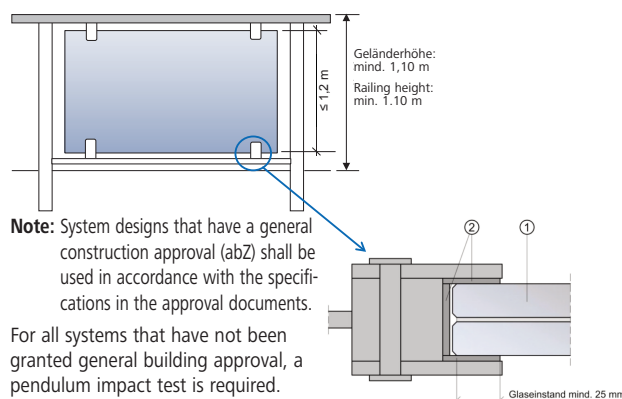

Note: System designs that have a general construction approval (abZ) shall be used in accordance with the specifications in the approval documents.

For all systems that have not been granted general building approval, a pendulum impact test is required. Minimum requirement: **LSG** comprising
 - 6 mm TSG + 1.52 mm PVB + 6 mm TSG,
 - 6 mm HSG + 1.52 mm PVB + 6 mm HSG shall be used.

Figure 5: Cross section of edge clamp holder

6.3 Balustrade with fixed horizontal bars (protection against falling is provided solely by sufficiently strong handrails and knee-height bars)

Alternative measures: If the proof calculations for Category C in accordance DIN 18008-4 are not submitted for accident-prevention (barrier) glazing, then the accident-prevention (barrier) attribute can be achieved by installing adequately sturdy knee-height cross-bars or tightly stretched steel rope (at least 5 mm diameter) at a **vertical spacing of not more than 35 cm** and at an adequate distance in front of the glass sheets of the balustrade infill.

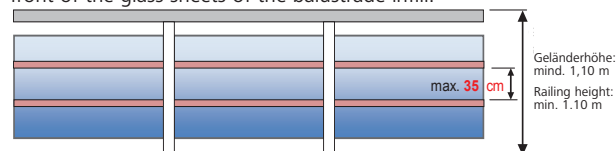

Note: In this case (with horizontal bars), the type of glass used can meet the specifications of Part 9 - Table A, glazing not intended to protect against falls. In the case of accident prevention balustrades in areas that are freely accessible to the **general trade fair public**, only vertical cross-bars should be used at the above-mentioned distance in front of the glass sheets, so as to prevent people (particularly children) from climbing over the balustrades.

7. Construction engineering regulations, generally accepted rules of engineering and references

- [1] Wörner J.-D., Schneider J., Fink A.: Glasbau: Grundlagen, Berechnung, Konstruktion, Springer-Verlag, Berlin Heidelberg; 2001
- [2] Bucak, Ö.: Glas im konstruktiven Ingenieurbau, in Stahlbau Kalender. Ernst & Sohn Verlag für Architektur und technische Wissenschaften GmbH, Berlin, 1999
- [3] Sedlacek S., Blank K., Laufs W., Güsgen J.: Glas im Konstruktiven Ingenieurbau. (1st ed.) Ernst & Sohn Verlag für Architektur und technische Wissenschaften GmbH, Berlin, 1999
- [4] Siebert G.: Entwurf und Bemessung von tragenden Bauteilen aus Glas. Ernst & Sohn Verlag für Architektur und technische Wissenschaften GmbH, Berlin, 2001
- [5] Bucak, Ö.; Schuler, C: Glas im Konstruktiven Ingenieurbau, in Stahlbau Kalender. Ernst & Sohn Verlag für Architektur und technische Wissenschaften GmbH, Berlin, 2008
- [6] Feldmann, M.; Kasper, R.: Glasbau im europäischen Kontext, in Stahlbau Kalender. Ernst & Sohn Verlag für Architektur und technische Wissenschaften GmbH, Berlin, 2015
- [7] Weller, B., Krampe, P., Reich, S.: Glasbau-Praxis, Konstruktion und Bemessung, 3rd ed., vol. 1: Grundlagen, Beuth Verlag GmbH Berlin, Vienna Zurich 2013
- [8] Weller, B., Engelmann, M., Nicklisch, F., Weimar, T.: Glasbau-Praxis, Konstruktion und Bemessung, 3rd ed., vol. 2: Beispiele nach DIN 18008, Beuth Verlag GmbH Berlin, Vienna Zurich 2013
- [9] Wörner, J.-D; Schneider J.: Abschlussbericht zur experimentellen und rechnerischen Bestimmung der dynamischen Belastung von Verglasungen durch weichen Stoß, Fraunhofer IRB Verlag Stuttgart 2000, Heft T 2935
- [10] Völkel, G. E.; Rück R.: Untersuchung von vierseitig linienförmig gelagerten Scheiben bei Stoßbelastung, Fraunhofer IRB Verlag Stuttgart 2000, Heft T 2915
- [11] Weller, B., Nicklisch, F., Thieme, S. Weimar, T.: Glasbau-Praxis in Beispielen, Konstruktion und Berechnung, Bauwerk-Verlag, 2nd ed. 2010
- [12] DIN 18008-1 (December 2010) Glass in building design and construction rules - Part 1: Terms and general bases
- [13] DIN 18008-2 (Dezember 2010) Glass in building design and construction rules - Part 1: Terms and general bases – Part 2: Linearly supported glazings
- [14] DIN 18008-3 (July 2013) Glass in building design and construction rules - Part 3: Point fixed glazing
- [15] DIN 18008-4 (July 2013) Glass in building design and construction rules - Part 4: Additional requirements for barrier glazing
- [16] DIN 18008-5 (July 2013) Glass in Building design and construction rules - Part 5: Additional requirements for walk-on glazing
- [17] Kasper, R., Pieplow, K., Feldmann, M.: Beispiele zur Bemessung von Glasbauteilen nach DIN 18008; Ernst & Sohn Verlag für Architektur und technische Wissenschaften GmbH, Berlin, 2016
- [18] Wellershof, F.: Bemessungsschubmodule für Verbundglasscheiben, Stahlbau 76 (März 2007), H.3, S. 177 188
- [19] Building Rules List (see www.dibt.de)
- [20] ETB Guideline: Building components designed to prevent falls (June 1985))

8. Abbreviations

abZ	German: Allgemeine bauaufsichtliche Zulassung (general construction approval)
C1, C3	Categories for vertically acting working loads on floors of public meeting spaces in buildings as specified in DIN EN 1991-1-1 / NA
DIBt	Deutsches Institut für Bautechnik (German civil engineering institute)
ESG	German: Einscheiben-Sicherheitsglas (fully-tempered glass / toughened safety glass)
HSG	Heat-strengthened glass
LSG	Laminated safety glass
PPG	Polished plate glass
PVB	polyvinyl butyral (intermediate film material for LSG)
SGP	SentryGlas® plus (intermediate film material for LSG)
SLS	Serviceability limit state
SPG	German: Spiegelglas (float glass or PPG)
T2	Category for vertically acting working loads on stairs / staircase landings for large traffic loads and escape staircases as specified in DIN EN 1991-1-1 / NA
TSG	Toughened safety glass
TVG	German: Teilvorgespanntes Glas (heat-strengthened glass)
ULS	Ultimate limit state
VSG	German: Verbund-Sicherheitsglas (laminated safety glass)
ZiE	German: Zustimmung im Einzelfall (individual construction approval)

Information Sheet "Glass in stand construction inside trade fair halls" 2023 (continued)

9. Spreadsheets A – D (for stand construction)

Table A: Vertical glazing, not intended to prevent falls

1	2	3	4	5	6	7	8	9	10	11	12	13	14	15
Structure type	Character-istic	Structure	Sheet support	Glass type	Allowed, yes/no	Glass thickness in mm	SGP/PVB film thickness	Width in mm	Height in mm	Min. glass insertion depth in mm	Type of proof required	Civil engineering rules		
Type						min.	max.	min.	max.					
		Glass wall	Linear support on 2 sides	TSG LSG 2 layers Wire glass Acrylic glass	yes yes yes yes						1			
		Glass wall	Linear support on 4 sides	TSG LSG 2 layers Wire glass Acrylic glass	yes yes yes yes						1	2)		
		Glass wall	Point supports	TSG LSG 2 layers Wire glass Acrylic glass	yes no yes yes						1	2)		
		Glass wall	Linear support on 2 sides	TSG LSG 2 layers Wire glass Acrylic glass	yes yes yes yes						1	DIN 18008-1/2 DIN 18008-1/2		
		Glass wall	Linear support on 4 sides	TSG LSG 2 layers Wire glass Acrylic glass	yes yes yes yes						1	DIN 18008-1/2 DIN 18008-1/2		
		Glass wall	Point supports	TSG LSG 2 layers Wire glass Acrylic glass	yes yes yes yes						1	DIN 18008-1...3 DIN 18008-1...3		
		Glass wall	Linear support on 2 sides	TSG LSG 2 layers Wire glass Acrylic glass	no yes yes yes						1.5	DIN 18008-1/2 DIN 18008-1/2		
		Glass wall	Linear support on 4 sides	TSG LSG 2 layers Wire glass Acrylic glass	yes yes yes yes						1	DIN 18008-1/2 DIN 18008-1/2		
		Glass wall	Point supports	TSG LSG 2 layers Wire glass Acrylic glass	yes yes yes yes						1	DIN 18008-1...3 DIN 18008-1...3		
		Glass wall	Linear support on 2 sides	TSG LSG 2 layers Wire glass Acrylic glass	yes yes yes yes						1	DIN 18008-1/2 DIN 18008-1/2		
		Glass wall	Linear support on 4 sides	TSG LSG 2 layers Wire glass Acrylic glass	yes yes yes yes						1	DIN 18008-1/2 DIN 18008-1/2		
		Glass wall	Point supports	TSG LSG 2 layers Wire glass Acrylic glass	no yes yes yes						1	DIN 18008-1...3 DIN 18008-1...3		
		Glass wall	Linear support on 2 sides	TSG LSG 2 layers Wire glass Acrylic glass	yes yes yes yes						1	DIN 18008-1/2 DIN 18008-1/2		
		Glass wall	Linear support on 4 sides	TSG LSG 2 layers Wire glass Acrylic glass	yes yes yes yes						1	DIN 18008-1/2 DIN 18008-1/2		
		Glass wall	Point supports	TSG LSG 2 layers Wire glass Acrylic glass	no yes yes yes						1	DIN 18008-1...3 DIN 18008-1...3		

Proof type [column 14]:

- 1: No specific proof
- 2: Verified static calculations
- 3: Installation appr. for spec. case
- 4: Pendulum impact test
- 5: Heat soak test
- 6: Residual load-bearing cap. test
- 7: Shock impact resistance test

1) Proof type 2 (verified static design calculations) are not required for sheet areas $A \leq 1.6 \text{ m}^2$ and $d \geq 4 \text{ mm}$
 2) Wire glass may continue to be used in existing components if documentation has been submitted of compliance with the technical standards in effect at the time of initial installation.

Information Sheet "Glass in stand construction inside trade fair halls" 2023 (continued)

Table B: Vertical glazing, intended to prevent falls (barrier glazing)

1	2	3	4	5	6	7	8	9	10	11	12	13	14	15
Structure type	Character-istic	Structure	Sheet support	Glass type	Allowed, yes/no	Glass thickness in mm	SGP/PVB film thickness	Width in mm	Height in mm	Min. glass insertion depth in mm	Type of proof required	Civil engineering rules		
Type						min.	max.	min.	max.					
Vertical glazing	Fall-prevention, barrier ($\Delta h > 1 \text{ m}$)	Glass wall (cat. A as defined in TRAV)	Linear support on 2 sides	TSG LSG 2 layers	no ²⁾ yes		0.76			18	2, 4	DIN 18008-1/2/4		
			Linear support on 4 sides	TSG LSG 2 layers	yes	2 x 6 Float 2 x 8 Float 2 x 10 Float 2 x 6 Float 2 x 8 Float 2 x 10 Float 2 x 6 Float	0.76 0.76 0.76 0.76 0.76 0.76	500 1000 1000 500 1000 1000 500	1200 1500 2100 2000 1500 2100 3000	1000 1000 1000 1000 1000 1000 500	2 2 2 2 2 2 2	DIN 18008-1/2/4		
			Point supports	TSG LSG 2 layers LSG 2 layers LSG 2 layers LSG 2 layers	no ²⁾ yes yes yes yes	2 x 10 HSG 2 x 8 TSG 2 x 10 TSG 2 x 10 TSG 2 x 10 TSG	1.52 1.52 1.52 1.52 1.52	1200 ³⁾ 1200 ³⁾ 1600 ³⁾ 1600 ³⁾ 2000 ³⁾	1600 ³⁾ 1600 ³⁾ 1800 ³⁾ 1800 ³⁾ 2000 ³⁾	2 2 2 2 2	2, 3, 4	DIN 18008-1...4 DIN 18008-1...4 DIN 18008-1...4 DIN 18008-1...4 DIN 18008-1...4		
			Linear clamping at one edge	TSG LSG 2 layers LSG 2 layers	no ²⁾ yes yes	2 x 10 TSG 2 x 10 HSG 2 x 10 HSG	1.52 1.52 1.52	2000 2000	1100 1100	900 900	1100 1100	100 100	2 2	DIN 18008-1/2/4 DIN 18008-1/2/4
			Linear support on 2 sides	LSG 2 layers	yes	2 x 6 Float 2 x 5 TSG 2 x 8 Float	0.76 0.76 1.52	1000 800 800	as desired	500	800 1100 1100	18	2	DIN 18008-1/2/4
			Linear support on 4 sides	TSG LSG 2 layers	no ²⁾ yes	2 x 6 Float 2 x 8 TSG 2 x 8 TSG	0.76 0.76 1.52	800 500 1100	800 1100 1100	1000 800	1100	18	2	DIN 18008-1/2/4
			Point supports	TSG LSG 2 layers LSG 2 layers LSG 2 layers LSG 2 layers	no ²⁾ yes yes yes yes	2 x 5 Float 2 x 6 TSG 2 x 8 TSG 2 x 8 HSG 2 x 6 HSG	0.76 1.52 1.52 1.52 1.52	2000 1200 ³⁾ 1600 ³⁾ 1200 ³⁾ 1600 ³⁾	1000 700 ³⁾ 800 ³⁾ 700 ³⁾ 800 ³⁾	500 500 500	1000 700 800 700 800	12 12	2, 4 2	DIN 18008-1/2/4 DIN 18008-1...4 DIN 18008-1...4 DIN 18008-1...4 DIN 18008-1...4
			Linear support on 2 sides	TSG LSG 2 layers	yes no ²⁾	2 x 6 Float 2 x 8 TSG 2 x 8 TSG	0.76 1.52 1.52	1800 1800 2000	1800 1800 2000	1000 1000	1800 1800 2000	18	2, 4	DIN 18008-1/2/4 DIN 18008-1/2/4 DIN 18008-1/2/4
			Linear support on 4 sides	TSG LSG 2 layers	yes no ²⁾	2 x 5 Float 2 x 6 TSG 2 x 8 TSG	0.76 1.52 1.52	1500 1500 2000	1500 1500 2000	500 500	1500 1500 2000	12	2, 3, 4	DIN 18008-1...4 DIN 18008-1...4 DIN 18008-1...4

Proof type [column 14]:

- 1: No specific proof
 - 2: Verified static calculations
 - 3: Installation apr. for spec. case
 - 4: Pendulum impact test
 - 5: Heat soak test
 - 6: Residual load-bearing cap. test
 - 7: Shock impact resistance test
- If a pendulum impact test, proof type "4", is not specified in column 14, then this advantage is subject to adherence to the limit values stated in columns 7 to 13. Structural designs not listed here will require an Installation Approval for the Specific Case.
- 2) In systems having a valid general statutory construction approval, LSG may be used in accordance with the text of the approval documents.
 - 3) The distance between neighbouring point supports in x-direction and in y-direction, respectively.
 - 4) Clamped on both faces by circular plates with diameter $d \geq 50 \text{ mm}$, if spacing is greater than 1200 mm, plate diameter shall be $d \geq 70 \text{ mm}$, see DIN 18008-3/4
- The use of acrylic glass and wire glass is **not allowed** for vertical glazing intended to prevent falls (barrier glazing). If the sheets are held in linear supports, LSG made of HSG and with the same specified thicknesses may be used instead of LSG made of float glass.

Information Sheet "Glass in stand construction inside trade fair halls" 2023 (continued)

Table C: Horizontal glazing

1	2	3	4	5	6	7	8	9	10	11	12	13	14	15	
Structure type	Characteristic	Structure	Sheet support	Glass type	Allowed, yes/no	Glass thickness in mm top / ¹ / centre / ¹ / bottom / ¹ / = 1,52 mm PVB / ¹ /SGF	SGP/PVB film thickness	Length in mm min. max.	Width in mm min. max.	Min. glass insertion depth in mm	Type of proof required	Civil engineering rules			
Overhead glazing (angled at > 10° to the vertical) ³⁾	Linear support on 2 sides			TSG	no		0,76		1200 ⁴⁾				2 ⁵⁾	DIN 18008-1/2 ⁶⁾	
				LSG 2 layers	yes		700 ⁴⁾				15	2			
	Linear support on 4 sides			TSG	no		0,76						2 ⁵⁾	DIN 18008-1/2 ⁶⁾	
				LSG 2 layers	yes		700 ⁴⁾				15	2			
	Point supports			TSG	no		1,52						2, 3, 6 ⁸⁾	DIN 18008-1...3	
				LSG 2 layers	yes						30	2			
	Linear support on 2 sides			TSG	no									2 ⁵⁾	DIN 18008-1...5
				LSG 2 layers	yes										
	Linear support on 4 sides			TSG	no										
				LSG 2 layers	yes										
Horizontal glazing capable of supporting persons (to be walked on)	Installed at height < 20 cm			8 HSG / ¹ / 10 Float / ¹ / 10 Float	yes		1,52	1500	400	30	2		DIN 18008-1...5		
				8 HSG / ¹ / 12 Float / ¹ / 12 Float	yes		1,52	1500	750	30	2		DIN 18008-1...5		
	Point supports			TSG	no										
				LSG 2 layers	yes										
	Linear support on 2 sides			TSG	no										
				LSG 2 layers	yes										
	Linear support on 4 sides			TSG	no										
				LSG 2 layers	yes										
	Installed at height < 20 cm			TSG	no										
				LSG 2 layers	yes										
Proof type [column 14]:	No specific proof			Wire glass	no								2 ⁹⁾	DIN 18008-1...5	
				TSG	no										
	Verified static calculations			LSG 2 layers	no										
				VSG 3 layers	yes										
	Installation appr. for spec. case			Wire glass	no										
				TSG	no										
	Pendulum impact test			LSG 2 layers	no										
				VSG 3 layers	yes										
	Heat soak test			Wire glass	no										
				TSG	no										
Residual load-bearing cap. test			LSG 2 layers	no											
			VSG 3 layers	yes											
Shock impact resistance test			Wire glass	no											
			TSG	no											

Proof type [column 14]:

1: No specific proof

2: Verified static calculations

3: Installation appr. for spec. case

4: Pendulum impact test

5: Heat soak test

6: Residual load-bearing cap. test

7: Shock impact resistance test

3) Overhead glazing that has to be capable of supporting human loads to permit cleaning is subject to a special approval procedure.

4) The data apply to the smaller distance between supports (support direction).

5) If HSG which has not received general statutory construction approval (abZ) is used, an additional Installation Approval for the Specific Case is required.

6) If glass type/support type combination systems which have been granted a general statutory construction approval (abZ) are used, the Installation Approval for the Specific Case is not required

7) Wire glass may continue to be used in existing components if documentation has been submitted of compliance with the technical standards in effect at the time of initial installation.

The use of acrylic glass for horizontal glazing is not allowed. However, exceptions may be possible if the trade-fair company has no objections with regard to fire prevention/protection and structural stability.

Table D: Recommended institutions for conducting component tests of glass designs

Technische Universität Dresden,

Institut für Baukonstruktionen (Beyer-Bau)

Prof. Dr.-Ing. Weller
August-Bebel-Straße 30
01219 Dresden

FMPA Baden-Württemberg

FB 2, Abt. 21, Referat 214
Pfaffenwaldring 4
70569 Stuttgart (Vaihingen)

MFPA Leipzig GmbH

Hans-Weigel-Straße 2B
04319 Leipzig

Universität Karlsruhe

Versuchsanstalt für Stahl, Holz und Steine

Prof. Dr.-Ing. Ummenhofer
Otto-Amman-Platz 1
76131 Karlsruhe

TU Hamburg - Harburg

Institut für Baustatik und Stahlbau

Prof. Dr.-Ing. Starossek
Denickestraße 7
21073 Hamburg

Friedmann & Kirchner

Gesellschaft für Material- und Bauteilprüfung

Große Ahlmühle 7
76865 Rohrbach

Leibnitz-Universität Hannover

Institut für Massivbau

Prof. Dr.-Ing. Marx
Appelstraße 9a
30167 Hannover

FH München

Labor für Stahl- und Leichtmetallbau

Prof. Dr.-Ing. Bucak
Karlstraße 6
80333 München

Materialprüfanstalt für das Bauwesen Braunschweig

Beethovenstraße 52
38106 Braunschweig

TU München

Lehrstuhl für Metallbau

Prof. Dr.-Ing. Mensinger
Arcisstraße 21
80333 München

MPA Nordrhein-Westfalen

Marsbruchstraße 186
44287 Dortmund

Institut für Fenstertechnik e.V.

Theodor-Grietl-Straße 7-9
83025 Rosenheim

RWT Aachen

Lehrstuhl für Stahlbau

Prof. Dr.-Ing. Feldmann
Mies-van-der-Rohe-Straße 1
52074 Aachen

MPA Darmstadt

Grafenstraße 2
64283 Darmstadt

TU Darmstadt

Institut für Werkstoffe und Mechanik im Bauwesen

Prof. Dr.-Ing. Wörner
Franziska-Braun-Straße 3
64287 Darmstadt